

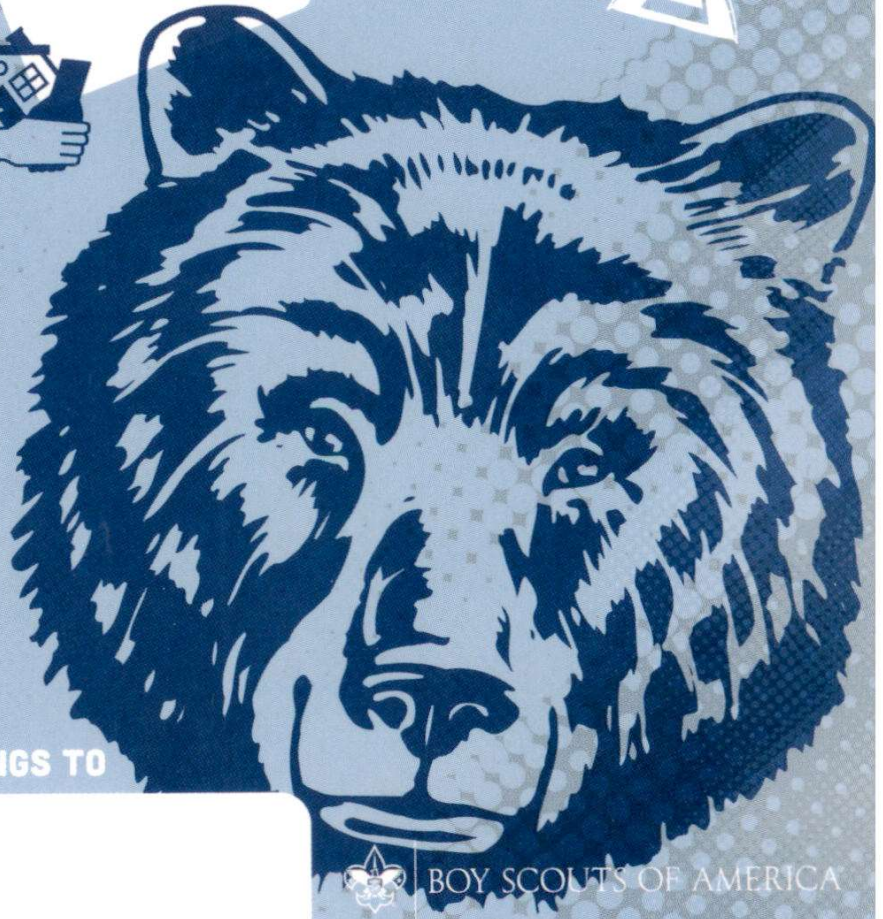

**3RD GRADE**

**BEAR CUB  
SCOUT  
HANDBOOK**

# BEAR



**THIS BOOK BELONGS TO**



BOY SCOUTS OF AMERICA



Q: Why do bears hibernate for so long?

A: Because no one is brave enough to wake them up.

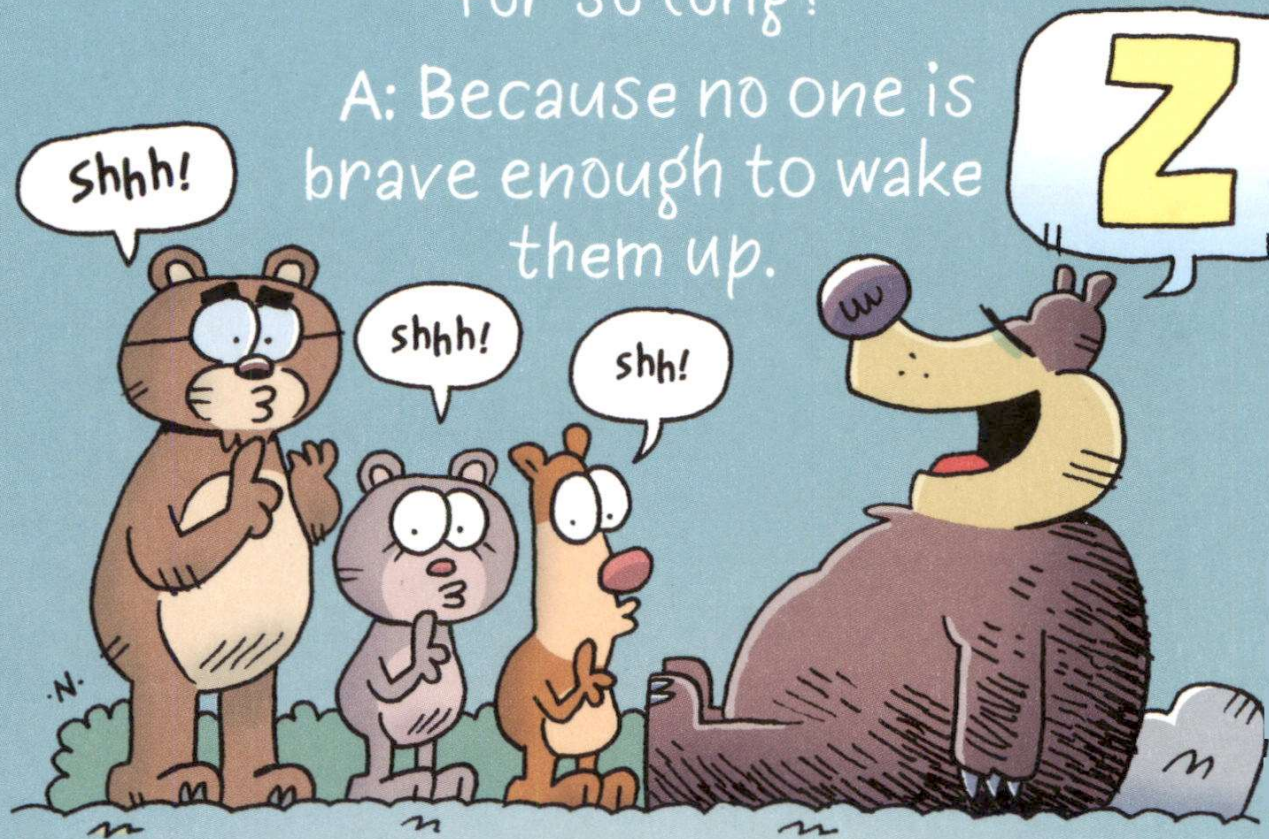

Impress your friends and family with the best jokes. Laugh at the funniest comics. Be inspired by the heroes of Scouts in Action. And learn how to get the most out of Scouting. All in

**Scout Life** magazine. Subscribe today!

Use promo code **SLBEAR15** to get a special Scout discount at [go.scoutlife.org/subscribe](http://go.scoutlife.org/subscribe)

From the publisher of Boys' Life since 1911

**Scout Life**

**SEA STARS**

**Scout Life**

**REACH FOR THE SUMMIT**

Pick your next exciting experience at the Summit Bechtel Reserve.



# WELCOME, CUB SCOUT!

Follow the trail to earn your Bear badge of rank.

Bobcat is designed to be the first required Adventure.  
Remaining Adventures can be earned in any order.

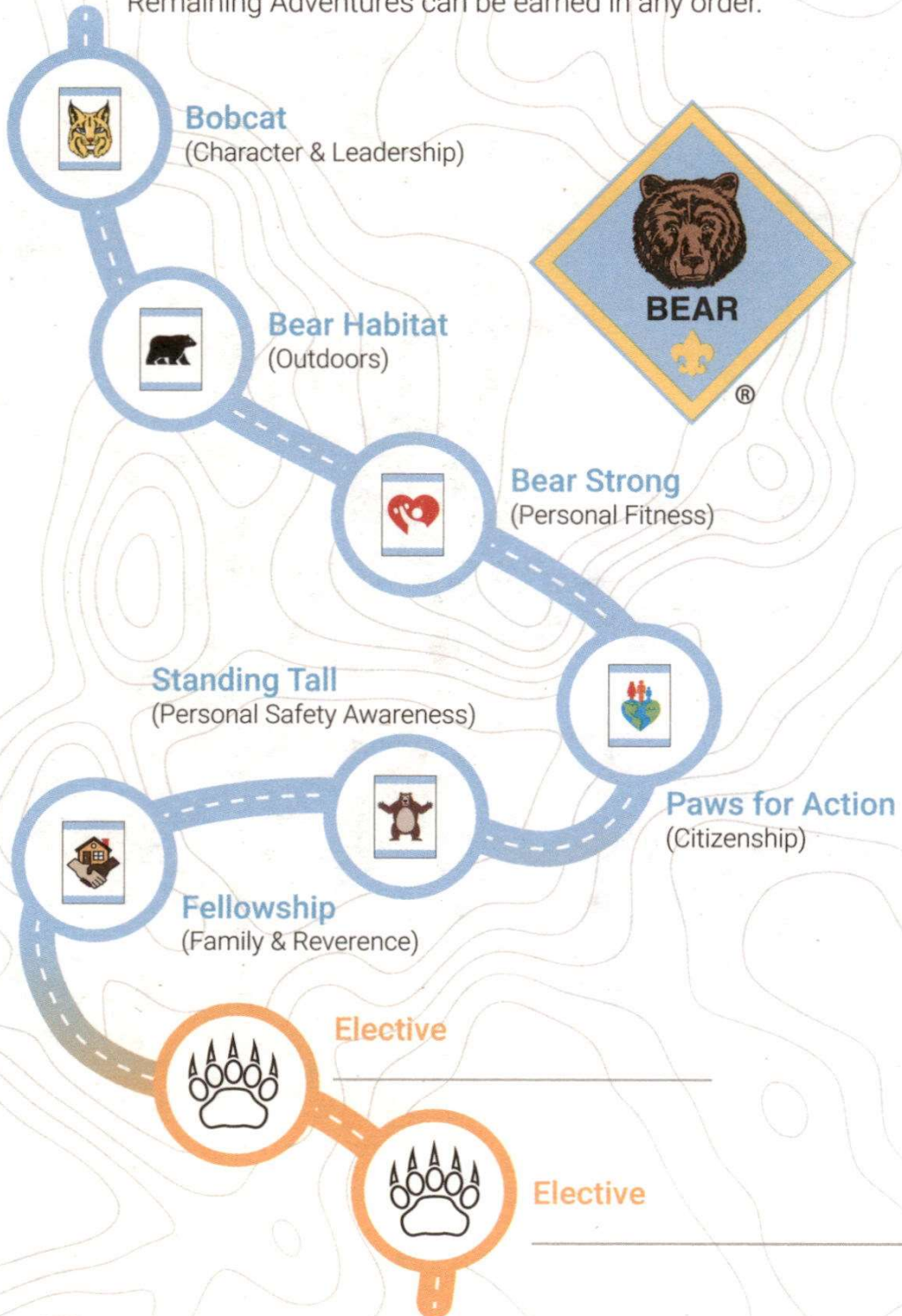

Fill in the circle when you complete an Adventure.



# BEAR

## HANDBOOK



Cub Scouts is about having fun,  
making friends, and doing your best.

Have a great time!

34753 660352  
ISBN 978-0-8395-0111-4  
©2023 Boy Scouts of America  
2024 Printing



# TABLE OF CONTENTS

Welcome to the Bear Adventure Trail .....	5
Cub Scout Parent Guide .....	6
Essential Cub Scout Family Activities .....	11
North American Bears .....	12
Your Cub Scout Pack .....	14
Your Cub Scout Bear Den .....	15
Your Cub Scout Adult Leaders .....	16
Your Cub Scout Bear Uniform .....	17
The Bear Adventure Trail .....	20
The Buddy System .....	23
The Cub Scout Six Essentials .....	24
What to Do if You Get Lost – STOP .....	29
The Outdoor Code .....	30
Leave No Trace Principles for Kids .....	31





## BEAR REQUIRED ADVENTURES

Bobcat (Character & Leadership) .....	34
Bear Habitat (Outdoors) .....	48
Bear Strong (Personal Fitness) .....	64
Paws for Action (Citizenship) .....	74
Standing Tall (Personal Safety Awareness) .....	88
Fellowship (Family & Reverence) .....	96

## BEAR ELECTIVE ADVENTURES

A Bear Goes Fishing .....	102
Balancing Bears .....	118
Baloo the Builder .....	126
Bears Afloat .....	152
Bears on Bikes .....	166
Champions for Nature .....	180
Chef Tech .....	190
Critter Care .....	198
Forensics .....	206
Let's Camp .....	220
Marble Madness .....	230
Race Time .....	240
Roaring Laughter .....	252
Salmon Run .....	264
Summertime Fun .....	278
Super Science .....	282
Whittling .....	292
Acknowledgments .....	302



# WELCOME TO THE BEAR ADVENTURE TRAIL

On the Bear Adventure Trail, you will explore the outdoors, make new friends, play games, and do things that only Cub Scouts do. As you are having fun, you will complete a group of activities called **Adventures**. After completing each Adventure, you will be given a metal belt loop that slides onto your Cub Scout belt. To earn the Bear badge of rank, you will need to complete all six required Adventures and at least two elective Adventures. You may earn as many elective Adventures as you like. When you complete the third grade, you will begin your Webelos Adventure Trail.

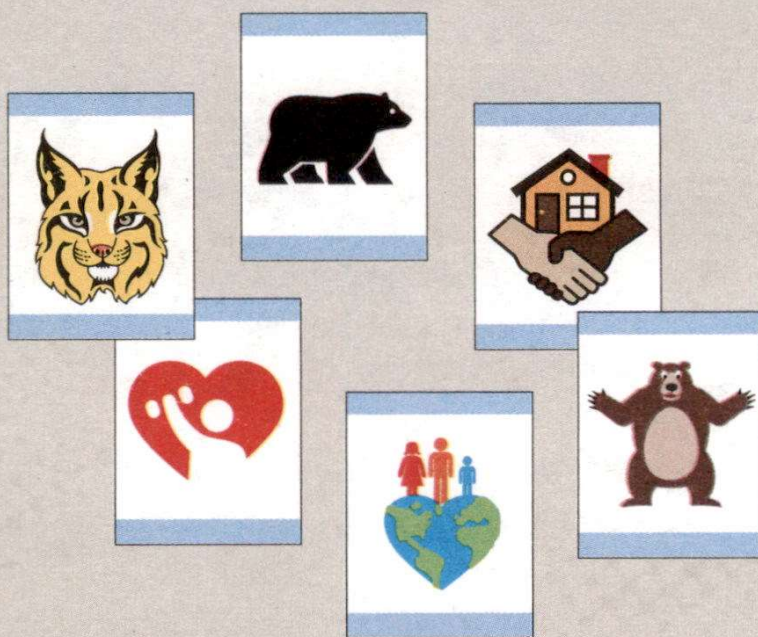



# CUB SCOUT PARENT GUIDE

(This section is for your parent or legal guardian.)

Your child will get the most out of their Cub Scout experience when you take an active part. Cub Scouting is led by volunteer parents, just like you. They come together to plan Cub Scout activities, meetings, and special events. For many parents, this is a great way to get to know the other families in their community. Chances are, you have a lot in common. Your child may attend the same school and some children may even have the same teachers. You may shop at the same grocery store, play at the same park, or may even live within walking distance from each other.

## GETTING STARTED AS A CUB SCOUT PARENT

1. **Find out who your contact person is for Cub Scouting.** The contact person may have a specific title like den leader or Cubmaster, or they just may be an active parent. This is the person whom you can contact to ask questions as you are getting started.
2. **Confirm the details of the den meetings,** pack meetings, and other activities. Add them to your personal and family calendars.
3. **Plug into the communication channel** that your pack and your den use. Each Cub Scout pack has a different way they communicate with parents; some have multiple ways. It may be as simple as a text message group, a communications app, or





a social media page. Make sure that the contact information you give to the Cub Scout pack is accurate.

- 4. Download the free Scouting app** from the Apple App Store® and Google Play™ store. The Scouting app gives parents an easy way to stay connected with their Cub Scout's progress and official records.
- 5. Read the remainder of this chapter**, Cub Scout Parent Guide, and the Essential Cub Scout Family Activities chapter.

## WHAT IS CUB SCOUTING?

Cub Scouting is the youth program of the Boy Scouts of America® (BSA) for kindergarten through fifth grade. The mission of the program is to prepare young people to make ethical and moral choices over their lifetimes by instilling in them the values of the Scout Oath and the Scout Law. This is accomplished through the aims and methods of Scouting – what we want to teach and how we teach.

The four aims are: character development, leadership, citizenship, and personal fitness.

The seven methods of Cub Scouts are: living the ideals, belonging to a den, advancement, family involvement, activities, serving the neighborhood, and the uniform.

Your child wanted to join and will stay in Cub Scouting because it is fun. Cub Scouting has been described as “a game with a purpose.” The activities in Cub Scouting serve a purpose deeper than just having fun. Activities are designed to meet the mission of the BSA.



## HOW CUB SCOUTING IS ORGANIZED

Later in this book, we describe how Cub Scouting is organized in a way your Bear Cub Scout can best understand. As an adult, we want you to have a deeper understanding of the BSA.

Think of the BSA as an upside-down pyramid. At the base of the pyramid – the smallest part – is the national organization of the BSA. It is designed to support the sections above it. The **National Council** of the BSA is led by a volunteer group called the National Executive Committee along with the chief executive officer, or the **Chief Scout Executive**. Additional volunteers and staff members make up the National Council, which includes departments such as Scout shops, program development, information technology, and safety.



The next part of the pyramid is your local council, a geographic territory that the National Council has granted permission to deliver Scouting programs within that area. The local council is also led by a volunteer group called the council executive committee, along with a chief executive officer called the **Scout executive**.

On the left sleeve of the Cub Scout uniform is a patch that identifies your local council.



Some councils create geographic areas called **districts**. Districts are designed to provide service and support to local Scouting programs in the designated area. A district committee made up of volunteers does this work and is often supported by a staff member called a **district executive**.

At the top of the pyramid – the largest part – are the local Scouting programs. Local councils partner with community organizations, called chartered organizations, to deliver Scouting



programs. Chartered organizations have an annual agreement with the local council to sponsor one or more Scouting programs.

If a chartered organization wants to have a Cub Scout program, it organizes what is called a Cub Scout **pack**. Packs are organized to best serve the families to whom the chartered organization is looking to deliver the program. Often, this is a school, neighborhood, or community. Your Cub Scout pack is identified with a number. Put your pack number on the left sleeve of your Cub Scout uniform under the council patch.

The **chartered organization representative** is just that, the person designated to represent the organization that has an agreement with the local council to deliver the Scouting program. The chartered organization approves all those who volunteer to be leaders in the pack, usually parents of Cub Scouts. Each pack has a pack committee made up of leaders and parents led by the **pack committee chair**. This volunteer, usually a parent, organizes the adults to plan and deliver the Cub Scouting program.

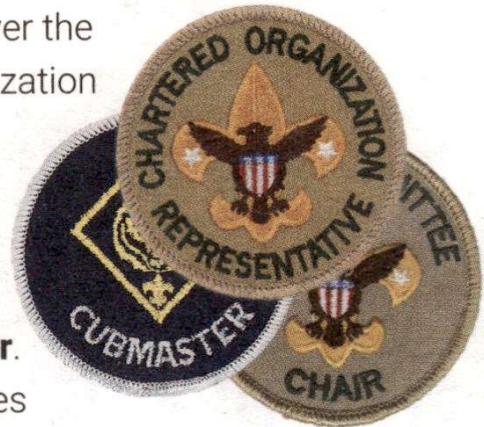

The **Cubmaster** is a volunteer, usually a parent, who coordinates the delivery of the program to the youth of all ages at the pack level, with the help of **assistant Cubmaster(s)** and other parents.

A Cub Scout pack is made up of small groups called **dens**. How dens are formed is up to the pack. Packs ultimately form dens in a way that best serves the families in the pack. Ideally, a den has about eight Cub Scouts who are all in the same grade and working on the same rank together. Dens can also be formed with different grades. A Cub Scout pack with three second graders (Wolves) and two third graders (Bears) may form a multi-rank den with those five Cub Scouts. Regardless of how dens are formed, Cub Scouts earn Adventures and the badge of rank only for their grade level.



The den is led by a volunteer **den leader** and **assistant den leader**, usually a parent. The den leader coordinates meetings and activities centered around Cub Scout **Adventures**. Adventures are made up of a group of activities. When the required activities for each Adventure are completed, the Cub Scout receives an **Adventure loop** that slides onto their Cub Scout belt as recognition for completing an Adventure.

**Advancement** refers to the progress your Cub Scout is making toward their badge of rank. Cub Scouts work only on the badge of rank associated with their grade level. For third grade, this is the Bear badge of rank. Your Cub Scout earns their **Bear** badge of rank by completing the six required Adventures and two elective Adventures. When they complete a badge of rank, they may not work on the next badge of rank until they have completed the grade level associated with that badge of rank. Cub Scouts may not work on a badge of rank for an earlier grade level.

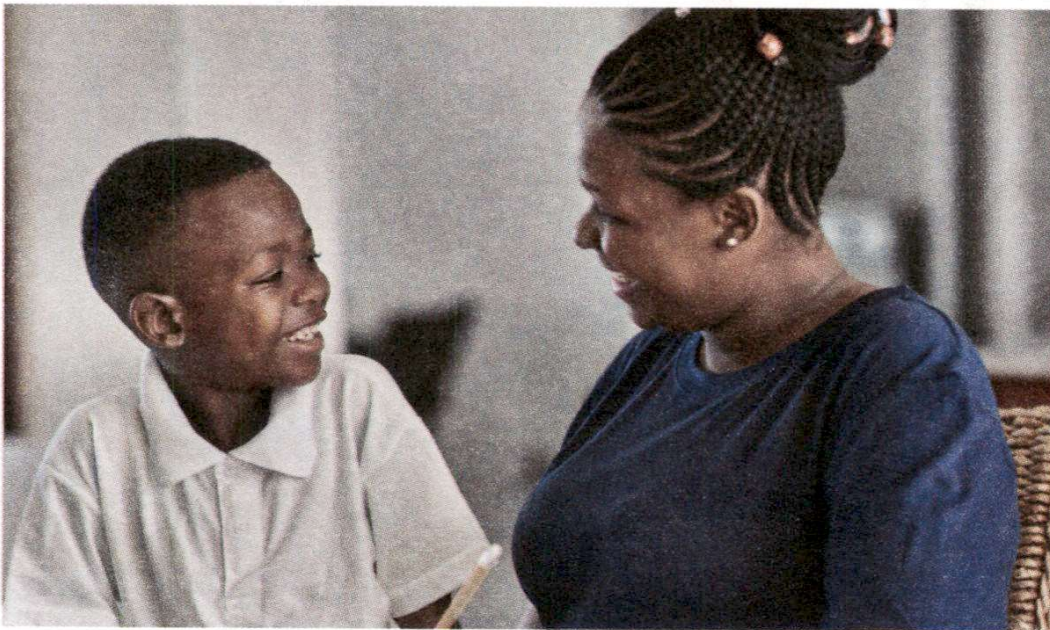



# ESSENTIAL CUB SCOUT FAMILY ACTIVITIES

The Cub Scout program is designed for you to share adventures together with your child. Be active, have fun, and enjoy the moments you have together. As an adult, you will also make new friends and have opportunities to try new things.

Cub Scouting is a holistic program; the positive impact works best when incorporated into your home. One way to do this is for you to be familiar with the Scout Oath and the Scout Law and look for ways to recognize your Cub Scout when they are following these values.

## ADVENTURE REQUIREMENTS TO DO AT HOME

Most Adventure requirements will be completed with your den or pack. The following requirements are designed to be done at home. Let your den leader know when you have completed them with your Cub Scout.

### BOBCAT

Requirement 8 – At home, with your parent or legal guardian, do the activities in the booklet “How to Protect Your Children From Child Abuse: A Parent’s Guide.”

### STANDING TALL

Your den leader may ask that you complete all requirements for this Adventure at home. See the requirements on page 89.

### FELLOWSHIP

Your den leader may ask that you complete all requirements for this Adventure at home. See the requirements on page 97.



## NORTH AMERICAN BEARS

Several types of bears live in North America. The most common is the American black bear. The black bear can be several shades of black or brown. The black bear is an omnivore, which means it eats plants and animals. You can find black bears in 40 of the 50 states in the United States.

Like most bears, the black bear eats a lot of food before winter. During the winter, there is less food to be found, and the bear will go into a deep sleep called hibernation. During this time, the bear will depend on the food it ate before it began to hibernate.



12 Bear



Black bears like to live in wooded areas that have a lot of vegetation and things to eat. At times, black bears will go into neighborhoods looking for food. Bears are not known to attack people unless they feel they are in danger.

When a mother bear is protecting her bear cubs (sometimes from another bear), she will train her bear cubs to run up a tree as she stands guard. When a bear feels that it or its bear cubs are in danger, it may try to scare off the danger by standing up on its back legs. This makes the bear look larger, which will usually scare off the danger.

The stories in *The Jungle Book* were written by Rudyard Kipling and have been made into several movies. One character in *The Jungle Book* is a wolf named Akela (Ah-KAY-la). Akela finds a lost child named Mowgli (MO-gee) and raises the child like a wolf. Baloo the bear helps teach Mowgli the laws of the jungle so he can live among the animals.

Cub Scouts in the United States used the names of these characters as a fun way to describe the Cub Scouting program. To this day, you may hear words like Akela, Baloo, den, and pack. That is our way of remembering how Cub Scouting began.



# YOUR CUB SCOUT PACK

You and your family are part of a Cub Scout pack. A pack is made up of several families that are part of Cub Scouting in your community. A pack includes Cub Scouts who are in kindergarten through fifth grade. The pack will get together for activities, meetings, and outings. The adult leader of the pack is called the **Cubmaster**. To make Cub Scouting more fun, packs form small groups called **dens**.





# YOUR CUB SCOUT BEAR DEN

Your den is the group in which you make new friends, play games, and earn Adventures as you work toward earning your Bear badge of rank. Each den is a little different. Most of your Cub Scout fun will be with your den. The adult leader of the den is called the **den leader**.





## YOUR CUB SCOUT ADULT LEADERS

You will see several adults in Cub Scouting; some you will be able to recognize right away because they are wearing a uniform. Other adults may be part of the pack but do not wear a uniform. As a Cub Scout always be respectful to adults in your Cub Scout pack.

**At no time is any adult, other than your parent or legal guardian, to be alone with you.**





# YOUR CUB SCOUT BEAR UNIFORM

Wearing your uniform shows everyone that you are a Cub Scout. Think of it as being part of one of the largest teams in America. Wear your uniform to pack meetings, den meetings, and special activities when you are with other Cub Scouts. There are times when you are going to get dirty in Cub Scouts; for those times it's OK to wear a Cub Scout t-shirt.



The uniform includes the blue Cub Scout shirt, blue Cub Scout bottoms (shorts, pants, or skort), the Cub Scout belt, and Cub Scout socks. Each rank has a hat, neckerchief and neckerchief slide with their own emblem and colors. The Bear hat and neckerchief are blue

Your Cub Scout belt is specially made so that your Cub Scout Adventure loops can slide onto it.









The pictures below show you where to put badges of rank and patches on your blue Cub Scout shirt. You might receive a patch for attending a special event like a campout or for selling popcorn. These are examples of “temporary insignia” and should be worn centered on the right pocket. Sometimes these patches come with a button loop, so you can hang your patch from your pocket button.

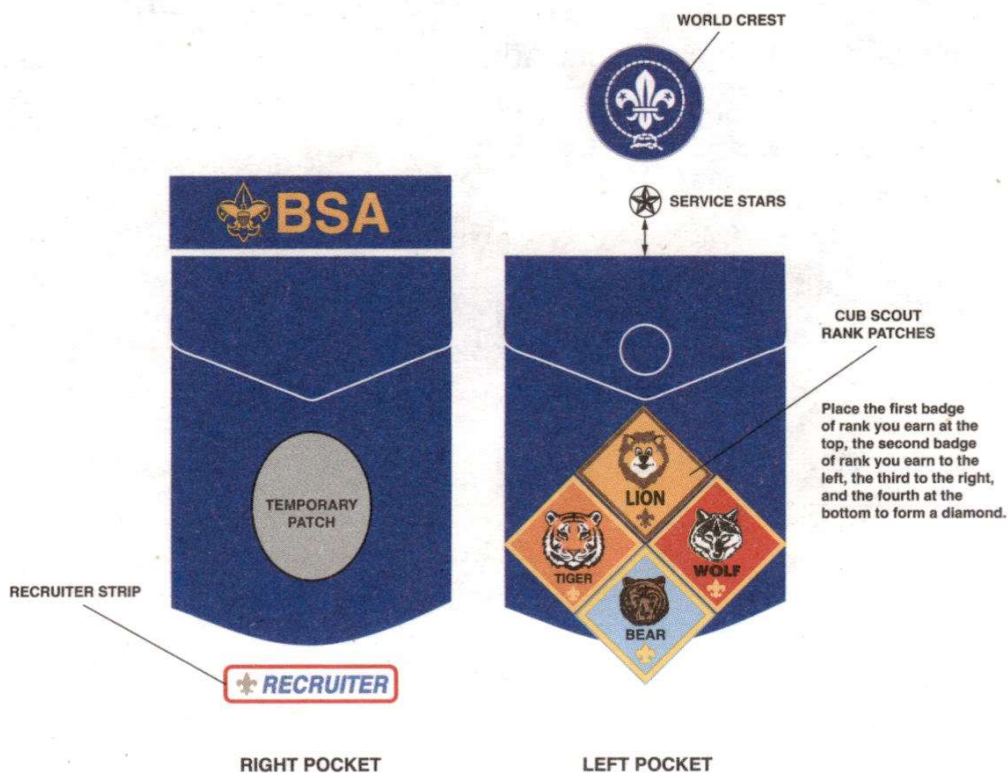



# THE BEAR ADVENTURE TRAIL

The Cub Scout activities that you do with your den, pack, and family are called Adventures. Each Adventure has several things you do to complete that Adventure. These are called requirements. You'll have fun completing the requirements with the help of your den, pack, and family.

When you complete a requirement for an Adventure, have your leader, parent or legal guardian confirm that you did your best by signing and dating your handbook like in the sample below.



*Sept 15*

Date

*A. Scouter*

Adult's signature

When you complete an Adventure, you are awarded a special metal belt loop. You slide your Adventure loops onto your belt. At the end of your Bear year, you can make a cool display for your Bear Adventure loops out of wooden paint stirrers.

Most of the Adventures you do will be with your den in your den meetings. Your Cub Scout pack may plan some activities that will help you earn an Adventure. You can complete other Adventures at home with your family.

To earn your Bear badge of rank, you must complete the six required Adventures and at least two elective Adventures. You have 20 elective Adventures to choose from.

**If you complete an Adventure or a requirement for an Adventure outside of your den meeting, let your den leader know so they can record it and make sure you are recognized for earning it.**



## REQUIRED ADVENTURES

Must complete each of the 6 required adventures



### Bobcat

(Character & Leadership)



### Bear Habitat

(Outdoors)



### Bear Strong

(Personal Fitness)



### Paws for Action

(Citizenship)



### Standing Tall

(Personal Safety Awareness)



### Fellowship

(Family & Reverence)



## ELECTIVE ADVENTURES

Must complete at least 2 elective adventures



A Bear Goes Fishing



Balancing Bears



Baloo the Builder



Bears Afloat



Bears on Bikes



Champions for Nature



Chef Tech



Critter Care



Forensics



Let's Camp

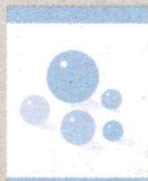

Marble Madness



Race Time



Roaring Laughter



Salmon Run



Summertime Fun

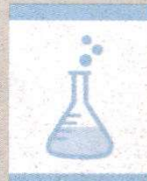

Super Science



Whittling



Archery\*



BBs\*



Slingshot\*

\* Range and target sports Adventures are special Adventures that can only be completed at approved events with qualified instructors.



## THE BUDDY SYSTEM

The buddy system is when two Cub Scouts work together, share, and keep each other safe. Your den leader decides how buddies are paired. If there is an odd number of Cub Scouts, you can have a buddy group of no more than three.

Having a buddy is especially important when you are doing an activity outdoors, particularly near or on the water.

When you have a buddy, you are not to let your buddy out of your sight. As buddies you are friends, so remember the points of the Scout Law to be friendly, courteous, and kind to each other. You keep each other safe by following any rules or instructions for the activity.

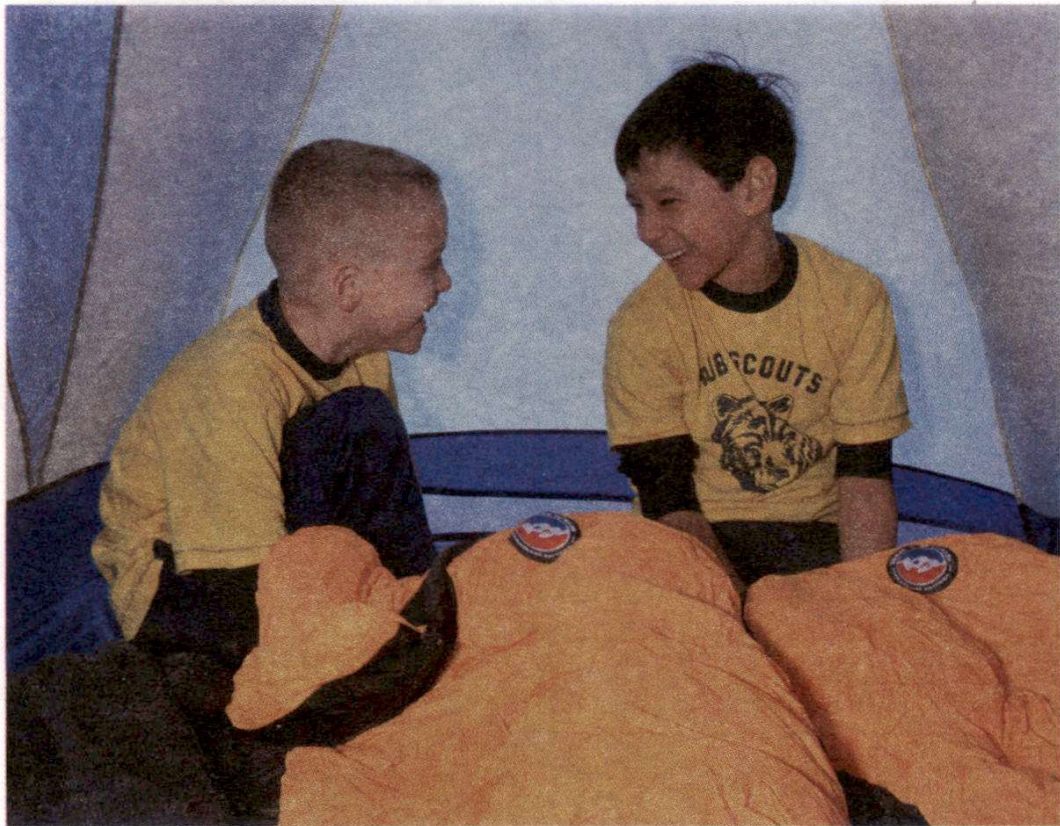



# THE CUB SCOUT SIX ESSENTIALS

Cub Scouts love being outdoors. When you go outdoors for an Adventure, there are six things you should bring with you. These are called the Cub Scout Six Essentials. If something is essential, it's extremely important.

## 1. FILLED WATER BOTTLE

No matter the weather or activity, your body always needs plenty of water to keep it going. You always carry water with you when you're going outside to replace the water your body loses by sweating and even just breathing. Have you ever seen your breath when it's cold outside? That's water your body has lost!

When your body has lost too much water, it will tell you it needs water in different ways. You'll feel thirsty, get a headache, or even get a stomachache.

Get in a good habit of drinking water when you plan to be outside. Drink before you start an activity, take small drinks during your activity, and drink again when you're finished. It is better to take a lot of small drinks than to drink a large amount all at once.





How do you know if you're drinking enough water? One way is by checking your urine (pee). Your urine should be clear and light. If

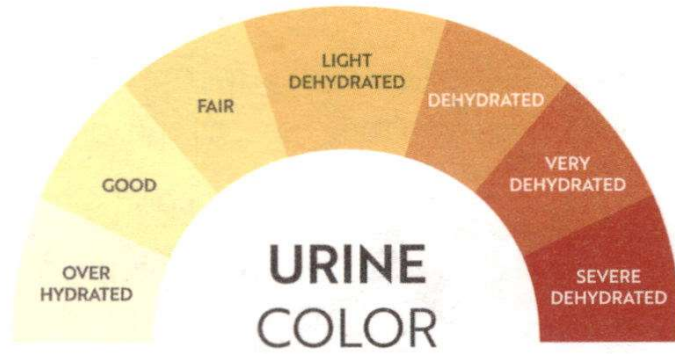

it's yellow, your body could use more water. If it's dark yellow, your body needs more water.

Plastic water bottles are the most popular way to carry water. These come in all shapes and sizes. When choosing a plastic water bottle, think about how you'll carry it and how much water it will hold. Another important part of a plastic water bottle is how you drink from it. Some have straws, some have a valve, and others have just an opening with a screw cap.

Some backpacks are designed to carry a water bladder with a flexible straw attached. These make drinking water easy and give you a place to carry your other Cub Scout essentials.

It is best to keep only water in your water bottle or water bladder. Make sure to wash it after each use to keep it clean.

## 2. FIRST-AID KIT

Carry a small and simple first-aid kit with things you know how to use. It should also include things you may need based on the activity you have planned. Always check your first-aid kit before going out to make sure it has what you need.





### **Your first-aid kit should have the following items:**

- ◆ Personal medical items (for example, if you are allergic to bee stings, you may need to carry an EpiPen)
- ◆ Pads (to clean cuts before applying an adhesive bandage)
- ◆ First-aid cream (applied to a cut before putting on an adhesive bandage)
- ◆ Adhesive bandages (only a few in two or three different sizes; include latex free)

As you learn more about first aid, you will begin to carry more items in your kit.

### **3. WHISTLE**

A whistle is for emergencies if you get separated from your group. If you lose sight of your group, use your whistle to let people know where to find you. Blow three loud, short blasts, counting to three in your head during each blast. Using a whistle in combination with the STOP method – Stay calm, Think, Observe, and Plan – will help people find you. You will learn more about STOP later in this handbook.



### **4. FLASHLIGHT**

Carry a flashlight in case your activity happens at night or goes later than you expect. Like a first-aid kit and whistle, it's better to have a flashlight and not need it than to need it and not have it.

When deciding what kind of flashlight to bring, remember you have to carry it. There are some you carry in your hands, some that you wear on your head, and even some that you wear around your neck.





You also want to consider how your flashlight is powered. What type of batteries does it use? Do the batteries come with the flashlight? Is it easy to replace the batteries? It's a good idea to carry some spare batteries with you.

When using your flashlight, remember to keep it pointed down and not at someone's face.

## 5. SUN PROTECTION

Just like you need water when it's hot or cold outside, you need sun protection in all types of weather, too. You can protect yourself from the sun by wearing appropriate clothing and using sunscreen.



Sunscreen and some clothes indicate a sun protection factor, or SPF. The higher the SPF number, the more protection the sunscreen or clothing will provide from the sun's damaging rays. The SPF number is not related to how long you can stay out in the sun. The effect the sun has on your skin can be different based on the time of year, time of day, and what type of skin you have.

A hat can provide good sun protection if it covers not only your head, but also your ears and neck. If your hat doesn't cover your ears or neck, make sure to apply sunscreen to those areas.

When using sunscreen, always follow the directions on the container. Know if your sunscreen is waterproof or sweatproof. If it isn't, you'll need to reapply if you get wet or sweat a lot. Most sunscreen will wear off after a while, and you'll need to apply more if you're outside for a longer period of time.



## 6. TRAIL FOOD

When you are outside and active, your body will need energy. Pack a snack that is easy to carry, is easy to eat when you are moving, and will stay fresh. Here are some ideas for trail food.

**GORP** – Good Old Raisins and Peanuts was the first trail mix and was simply raisins and peanuts. Raisins provided sugar and peanuts provided protein, two important nutrients for energy. Trail mix is now much more than just raisins and peanuts. Dried fruits, chocolate candies, and other nuts are just some items you can find in trail mix.

**Dried meats** like beef jerky and turkey jerky are another source of high-protein foods that make a good snack when outdoors. You can even find vegetarian jerky made from plant-based proteins.

**Granola** can be simply rolled oats, nuts, and honey baked together. Like trail mix, granola can be made from different ingredients. You can find a variety of granola bars at your grocery store.

When deciding on trail food, **remember what the temperature** will be like. If it is going to be warm outside, anything that has chocolate will melt, making it difficult to eat. If it is going to be 35 degrees or colder outside, you can consider packing cheese as your trail food.

When planning what to bring for trail food, make sure to **check with your den leader to see if anyone has a food allergy**, so you can plan to avoid those foods.





## WHAT TO DO IF YOU GET LOST — STOP

One day you might accidentally wander off a trail and be unsure how to find it again. Or you may take a wrong turn and not know which way to go. If you think you're lost, stop where you are and follow the four steps that spell STOP.

### STAY CALM. THINK. OBSERVE. PLAN.

**Stay calm.** Sit down and have some water and something to eat. If you're cold, put on a jacket or sweater. Breathe slowly and relax.

**Think.** Try to remember how you got where you are. If you have a map, open it and see what you can learn from the symbols and contour lines.

**Observe.** Look for your footprints in soft ground or snow. Notice any landmarks that can be clues to your location. Listen for sounds of other Scouts.

**Plan.** If you're convinced that you know which way to go to get back on track, move carefully. Use a compass to set a bearing in the direction of your destination. Then clearly mark the way you're going with broken branches, piles of stones, or whatever else is handy in case you need to find your way back to the spot where you've been sitting. If you don't have a clear idea where you are, though, stay right where you are. People will start looking for you as soon as someone realizes you're missing.



# THE OUTDOOR CODE

The outdoors is a focus of Cub Scouting. For more than 70 years, the Outdoor Code has been a guide for Scouts in the outdoors. Remember to do your best by showing respect for the outdoors and by learning and upholding the Outdoor Code.

## **As an American, I will do my best to:**

- **Be clean in my outdoor manners.**

A Cub Scout takes care of the outdoors and keeps the outdoors clean. A Cub Scout knows that putting marks on buildings, trees, or natural objects causes permanent damage.

- **Be careful with fire.**

A Cub Scout may enjoy a campfire only with adult leaders. A Cub Scout knows not to play with matches and lighters.

- **Be considerate in the outdoors.**

A Cub Scout shares our outdoor places and treats everything on the land and in the water with respect.

- **Be conservation-minded.**

A Cub Scout works to restore the health of the land so others may enjoy, live, and learn from it as a part of the Web of Life.





# LEAVE NO TRACE PRINCIPLES FOR KIDS

As a Cub Scout, you'll learn to use the Leave No Trace Principles for Kids to help you take care of the outdoors.



## 1. KNOW BEFORE YOU GO

- Be Prepared! Don't forget clothes that protect you from cold, heat, and rain.
- Use maps to show you where you'll be going so you won't get lost.
- Learn about the area you visit. Read books and talk to people before you go. The more you know, the more fun you'll have.

## 2. CHOOSE THE RIGHT PATH

- Stay on the main trail to protect nature, and don't wander off by yourself.
- Steer clear of flowers or small trees. Once hurt, they may not grow back.
- Use existing camp areas and camp at least 100 big steps from roads, trails, and water.



### 3. TRASH YOUR TRASH

- Pack it in, pack it out. Put litter, even crumbs, in trash cans or carry it home.
- Use bathrooms or outhouses when available. If you have to “go,” act like a cat and bury poop in a small hole 4-8 inches deep and 100 big steps from water.
- Place your toilet paper in a plastic bag and put the bag in a garbage can back home.
- Keep water clean. Do not put soap, food, or poop in lakes or streams.

### 4. LEAVE WHAT YOU FIND

- Leave plants, rocks, and historical items as you find them so the next person can enjoy them. Treat living plants with respect. Hacking or peeling plants can kill them.
- Good campsites are found, not made. Don’t dig trenches or build structures in your campsite.

### 5. BE CAREFUL WITH FIRE

- Use a camp stove for cooking. It’s easier to cook on and clean up than a fire.
- Be sure it’s OK to build a campfire in the area you’re visiting. Use an existing fire ring to protect the ground from heat. Keep your fire small. Remember, campfires aren’t for trash or food.
- Do not snap branches off live, dead, or downed trees. Instead, collect loose sticks from the ground.
- Burn all wood to ash, and be sure that the fire is completely out and cold before you leave.



## 6. RESPECT WILDLIFE

- Observe animals from a distance and never approach, feed, or follow them. Human food is unhealthy for all animals, and feeding them starts bad habits.
- Protect wildlife and your food by storing your meals and trash.
- Control pets at all times, or leave them at home.

## 7. BE KIND TO OTHERS

- Make sure the fun you have in the outdoors does not bother anyone else. Remember that other visitors are there to enjoy the outdoors.
- Listen to nature. Avoid making loud noises or yelling. You will see more animals if you are quiet.

**Remember** – you'll enjoy nature even more by caring for your special place.



\* The member-driven Leave No Trace Center for Outdoor Ethics teaches people how to enjoy the outdoors responsibly. This copyrighted information has been reprinted with permission from the Leave No Trace Center for Outdoor Ethics: [www.LNT.org](http://www.LNT.org).



# BOBCAT

CHARACTER & LEADERSHIP





## SNAPSHOT OF ADVENTURE



The Bobcat Adventure is the first required Adventure on your trail and will get you and your den off to a great start. Once you have completed the Bobcat Adventure, you can work on the other Adventures in any order.

### REQUIREMENTS

1. Get to know the members of your den.
2. Recite the Scout Oath and the Scout Law with your den and den leader.
3. Learn about the Scout Oath. Identify the three points of the Scout Oath.
4. With your den, create a den code of conduct.
5. Learn about the denner position and responsibilities.
6. Demonstrate the Cub Scout sign, Cub Scout salute, and Cub Scout handshake. Show how each is used.
7. Share with your den or family a time when you demonstrated the Cub Scout motto "Do Your Best." Explain why it is important to do your best.
8. At home, with your parent or legal guardian, do the activities in the booklet "How to Protect Your Children From Child Abuse: A Parent's Guide."



- [Required Adventure](#)
- [Scan for this Adventure page](#)



## REQUIREMENT 1

### Get to know the members of your den.

Getting to know others is one way to live by the Scout Oath and the Scout Law. When you get to know other people, you're being friendly. It is also a good way to practice being courteous, kind, cheerful, and even brave.

Your den may have Cub Scouts that you know from last year, you may have some new Cub Scouts, or you may be new to Cub Scouts. These are all good reasons why one of the first things you should do is get to know everyone in your den. If you have a new Cub Scout join your den later on, you and everyone in the den should be sure to make them feel welcome and get to know them, too.

If you don't know someone in your den, here are some things you can do to get to know them.

Introduce yourself. "Hi, my name is \_\_\_\_\_. What is your name?"

Ask them, "What are some things that you like to do?"

Tell them about the things you like to do.

Some people are shy. They may find it hard to interact with others and tend to stay away from the group. Be respectful of that, being friendly and inclusive with that person as best as you can. You may find that they may eventually decide to join you.

Remember, a Scout is friendly and kind. Next thing you know, you may have a new friend.



\_\_\_\_\_ Date

\_\_\_\_\_ Adult's Signature



## REQUIREMENT 2

Recite the Scout Oath and the Scout Law  
with your den and den leader.

One of the most important parts of earning the Bobcat Adventure is understanding that all Scouts believe in and work to live by the Scout Oath and the Scout Law. We learn those words and believe in them as a way to live our lives and be good members of our families, our communities, and the Cub Scout pack.



### SCOUT OATH

**On my honor I will do my best  
To do my duty to God and my country  
and to obey the Scout Law;  
To help other people at all times;  
To keep myself physically strong,  
mentally awake, and morally straight.**





## **The Meaning of the Scout Oath**

### **ON MY HONOR ...**

Saying "On my honor" is like saying "I promise."

### **I WILL DO MY BEST ...**

This means that you will do your best to do what the Scout Oath says.

### **TO DO MY DUTY ...**

A duty is something you are expected to do. At home, you might be expected to make up your bed or take out the trash. You also have duties to God and to your country.

### **TO GOD ...**

You do your duty to God by following the teachings of your family and religious leaders.

### **AND MY COUNTRY ...**

You do your duty to your country by being a good citizen and obeying the law.



**AND TO OBEY THE SCOUT LAW; ...**

You also promise to live by the 12 points of the Scout Law.

**TO HELP OTHER PEOPLE AT ALL TIMES; ...**

Many people need help. A friendly smile and a helping hand make life easier for others. By helping other people, you're doing a Good Turn and making our world a better place.

**TO KEEP MYSELF PHYSICALLY STRONG, ...**

This part of the Scout Oath is about taking care of yourself. You stay physically strong when you eat the right foods and get plenty of exercise.

**MENTALLY AWAKE, ...**

You stay mentally awake when you work hard in school, learn all you can, and ask questions.

**AND MORALLY STRAIGHT.**

You stay morally straight when you do the right thing and live your life with honesty.



\_\_\_\_\_ Date

\_\_\_\_\_ Adult's Signature



## REQUIREMENT 3

Learn about the Scout Oath. Identify the three points of the Scout Oath.

In the Scout Oath we make a promise to do our duty to three things.

Our first duty is to God and our Country. You do your duty to God by following the teachings of your family and religious leaders. You do your duty to your country by being a good citizen and obeying the law.

Our second duty is to help other people at all times. Many people need help. A friendly smile and a helping hand make life easier for others. By helping other people, you're doing a Good Turn and making our world a better place.

Our third duty is to ourselves. To keep ourselves physically strong, mentally awake, and morally straight. This part of the Scout Oath is about taking care of yourself. You stay physically strong when you eat the right foods and get plenty of exercise. You stay mentally awake when you work hard in school, learn all you can, and ask questions. You stay morally straight when you do the right thing and live your life with honesty.



\_\_\_\_\_

Date

\_\_\_\_\_

Adult's Signature

## REQUIREMENT 4

With your den, create a den code of conduct.

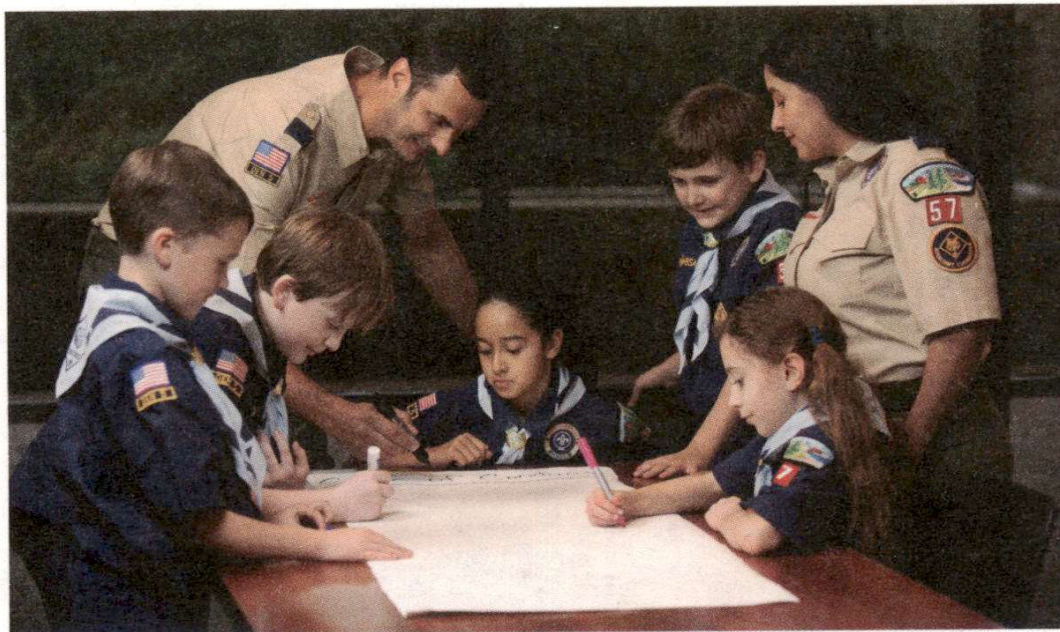

To create a den code of conduct, think about how you should act during a den meeting and how you expect everyone else to act.

The first step is to have everyone give their ideas of what should be part of the code of conduct. Then find the ones that everyone will agree to. If you can, make it a list of things you should do instead of a list of things you shouldn't do. It is also best to keep the list short and simple.

To get you started, here are two things you may want to add to your den code of conduct:

- ▶ Everyone will do their best to live by the Scout Oath and the Scout Law.
- ▶ We will do our best to make everyone feel welcome in our den.



\_\_\_\_\_ Date

\_\_\_\_\_ Adult's Signature



## REQUIREMENT 5

Learn about the denner position and responsibilities.



A denner is a Cub Scout who helps the den leader during a den meeting. The den leader decides how the denner will be chosen and for how long the Cub Scout will serve as the denner. Each Cub Scout should have a chance to serve as the denner for at least one meeting.

The den leader decides what the denner will help with, and that may change for each meeting. Here are some examples of things that a denner may be asked to do:

- ▶ Arrive early to help set up the meeting
- ▶ Welcome everyone when they arrive at the den meeting
- ▶ Lead the den in reciting the Scout Oath and the Scout Law

- ▶ Carry the United States flag during the opening
- ▶ Pick a game for the den to play
- ▶ Help hand out supplies for an activity
- ▶ Stay after the meeting to help clean up

When you're the denner, do your best to set an example for the other Cub Scouts by acting by the Scout Oath and the Scout Law. This is the greatest responsibility of a denner. This is called leadership by example. One way you can do this is to be friendly to everyone in the den and offer to help another Cub Scout who may need it.

When you're the denner, you may wear the denner cord — a yellow cord that is worn over your left shoulder. When you're no longer the denner, you'll pass the denner cord on to the next denner.

The denner is not the leader of the den and is never to be put in charge of other Cub Scouts.



---

Date

---

Adult's Signature



## REQUIREMENT 6

Demonstrate the Cub Scout sign, Cub Scout salute, and Cub Scout handshake. Show how each is used.



### The Cub Scout Sign

Make the sign with your right hand. Hold your arm straight up. The two raised fingers stand for the Scout Oath and the Scout Law. The fingers look like the sharp ears of the wolf ready to listen to Akela! Remember that Akela means "good leader" to a Cub Scout. Your den leader is Akela. Your mother or father or legal guardian is also Akela. At school, your teacher is Akela.

### The Cub Scout Salute

Salute with your right hand. Hold your first two fingers close together. Touch your fingertips to your cap. If you're not wearing a cap, touch your right eyebrow. We use the Cub Scout salute to show respect to our country. Always use the Cub Scout salute when you're in your Cub Scout uniform, both indoors and outdoors. If you're not in uniform, show respect to the flag by placing your right hand over your heart.



- ▶ We use the Cub Scout salute when the United States flag is being raised or lowered
- ▶ We use the Cub Scout salute when the United States flag is passing by in a parade.
- ▶ We use the Cub Scout salute when we are saying the Pledge of Allegiance.

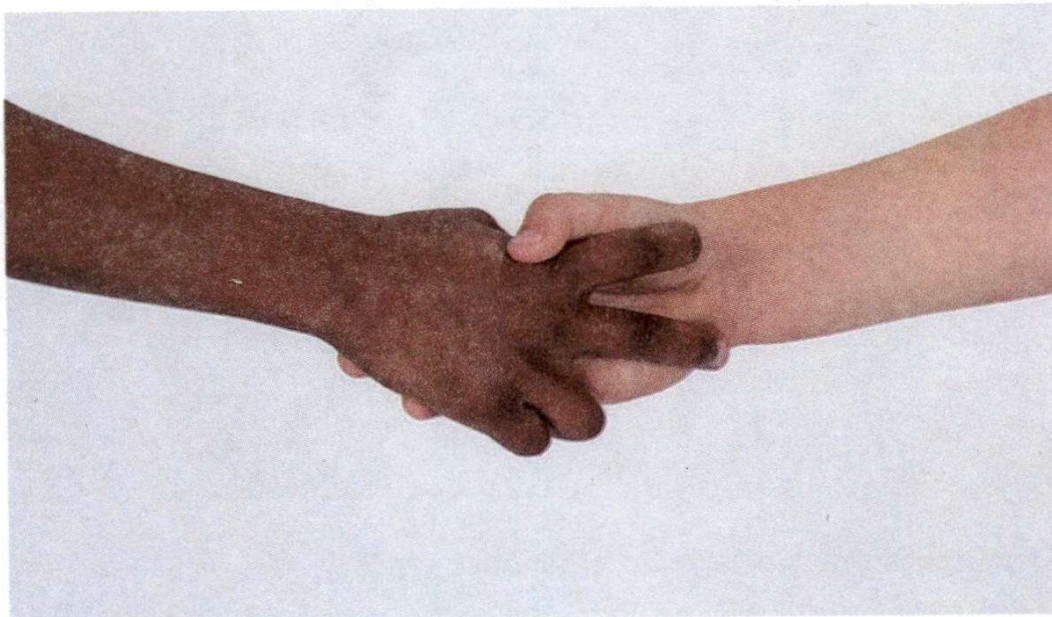

### **The Cub Scout Handshake**

When you shake hands with another Cub Scout, do this: Hold out your right hand just as you always do to shake hands. But then put your first two fingers along the inside of the other Scout's wrist. This means that you help each other to remember and obey the Scout Oath and Scout Law.



\_\_\_\_\_

Date

\_\_\_\_\_

Adult's Signature



## REQUIREMENT 7

Share with your den, or family, a time when you demonstrated the Cub Scout motto "Do Your Best."  
Explain why it is important to do your best.



### The Cub Scout Motto – Do Your Best

A motto is a rule for living. Do Your Best means trying your hardest, not just a little bit. Do your best all the time. Do your best in school and at home. Do your best when you play a game and help your team. Do your best as you work on your Cub Scout Adventures!

What is your best? You don't really know until you first try and then practice. People who are good at something didn't become good the first time they tried to do something. People who are good at something practice.

When doing your best, first try, then try it again and see if you get better. Remember that not trying is not doing your best.



\_\_\_\_\_

Date

\_\_\_\_\_

Adult's Signature

## REQUIREMENT 8

At home, with your parent or legal guardian, do the activities in the booklet "How To Protect Your Children From Child Abuse: A Parent's Guide."

Your parent(s) or legal guardian must read the booklet that is in front of your handbook. They can also find the online version by scanning this QR Code.

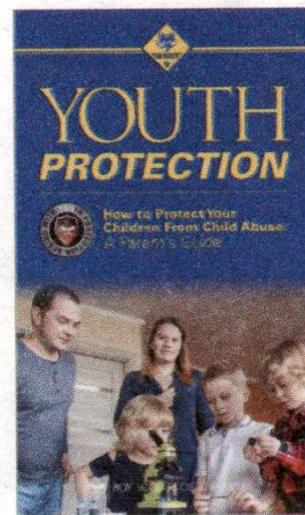

**CONGRATULATIONS!**

**You have completed your first required Bear Adventure!**



\_\_\_\_\_ Date

\_\_\_\_\_ Adult's Signature



# BEAR HABITAT

OUTDOORS



- Required Adventure
- Scan for this Adventure page



## SNAPSHOT OF ADVENTURE



A bear is at home in the outdoors, and so is a Bear Scout! In this Adventure, you'll learn how to plan a one-mile walk with your den. Your walk may be around where you live, it may be on a historical trail that has been in use for hundreds of years, or it may be on a nature trail.

When we are outside, we also have responsibilities to make sure that others can enjoy the outdoors, too. Knowing and following the Leave No Trace Principles for Kids helps us do just that.

### REQUIREMENTS

1. Prepare for a one-mile walk by gathering the Cub Scout Six Essentials and weather-appropriate clothing and shoes.
2. **"Know Before You Go"** Identify the location of your walk on a map and confirm your one-mile route.
3. **"Choose the Right Path"** Learn about the path and surrounding area you'll be walking on.
4. **"Trash Your Trash"** Make a plan for what you'll do with your personal trash or trash you find along the trail.
5. **"Leave What You Find"** Take pictures along your walk or bring a sketchbook to draw five things that you want to remember on your walk.
6. **"Be Careful With Fire"** Determine the fire danger rating along your path.
7. **"Respect Wildlife"** From a safe distance, identify as you look up, down, and around you, six signs of any mammals, birds, insects, or reptiles.
8. **"Be Kind to Other Visitors"** Identify what you need to do as a den to be kind to others on the path.
9. With your den, pack, or family, go on your one-mile walk while practicing your Leave No Trace Principles for Kids.



# REQUIREMENT 1

Prepare for a one-mile walk by gathering the Cub Scout Six Essentials and weather-appropriate clothing and shoes.

Being comfortable in the outdoors means taking along the right gear to keep you warm, dry, and safe. You don't need all the comforts of home, but a few key things can really help you enjoy your walk.

Talk with your den leader about what kind of clothing to wear on the walk. What you need to wear will depend on the season and where you live. It is also important to think about what time of day you'll be hiking. Layering is a good way to dress for places where the weather can be cold, hot, and in-between, all in one day.

Remember to bring your Cub Scout Six Essentials. You should take them on every outing.

## CUB SCOUT SIX ESSENTIALS



Filled water bottle



First-aid kit



Whistle



Flashlight  
(check the batteries)



Sun protection



Trail food



Date

Adult's Signature

## REQUIREMENT 2

“Know Before You Go” – identify the location of your walk on a map and confirm your one-mile route.

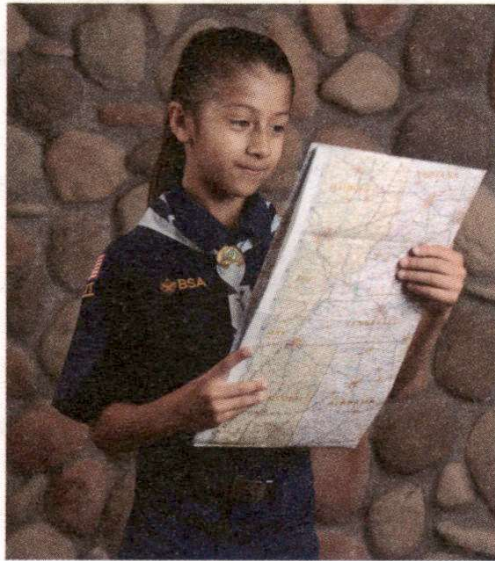

Using a map, identify where you'll take your walk. Look for a legend on the map to tell you the scale. The scale will tell you how far something is on the map compared to how far it is in real life. For example, when you open a map online you'll see somewhere on the map, often in the lower right corner, a distance with a line. This tells you that the

length of the line on the map is equal to a certain distance in real life. It may be in miles or feet. As you zoom in and out on the map, the size of the line and the distance will change.

Can you confirm that your route is at least one mile?



\_\_\_\_\_

Date

\_\_\_\_\_

Adult's Signature



## REQUIREMENT 3

“Choose the Right Path” — learn about the path and surrounding area you will be walking on.



The location where you take your walk may have been created a long time ago, like the Crawford Path, which was built in 1819 by Ethan Allen Crawford and his father, Abel. Located in New Hampshire, the path is 8.5 miles long. It is the oldest known continuously maintained hiking path in America that is still in use today.

Your walk may be part of a local park, greenway, or a rails-to-trails program where old railroad paths are converted to recreational paths. Or your route may simply be your neighborhood.

When learning about your path, there are some things you should look for:

- ▶ Where will everyone meet to start the walk, and where will you end?
- ▶ Does the path or area you plan to take your walk on have a name?
- ▶ Is the path marked? If so, how?
- ▶ Are there bathrooms?
- ▶ Is there a place to get drinking water?
- ▶ Is there something of interest that you may want to spend some time looking at, such as a historical marker, a special tree, or maybe even a playground?
- ▶ Are there trash cans?



---

Date

---

Adult's Signature



## REQUIREMENT 4

“Trash Your Trash” — make a plan for what you will do with your personal trash or trash you find on the trail.



If the path you're going to walk on doesn't have trash cans available, then you want to make sure that you hold onto any trash until you can properly dispose of it. If you eat a granola bar on the trail, where are you going to put the empty wrapper?

Your den or family should consider bringing a container for everyone to put their trash in such as a used plastic grocery bag or an empty trash bag.

If your den or family is going to pick up trash along the way, make sure you have gloves or use a tool like a trash picker so no one is touching the trash with their “bear” hands.



\_\_\_\_\_

Date

\_\_\_\_\_

Adult's Signature

## REQUIREMENT 5

“Leave What You Find” – take pictures along your walk or bring a sketchbook to draw five things that you want to remember on your walk.

Taking pictures or sketching the things you see on your walk is a great way to share what you saw with those who were not with you. It also helps you remember the walk.



It's always a good idea to keep a small journal of your outdoor activities. This is a great time to start one. Notice who was on the trail with you and write down their names. Record the time and date of your walk, too, including the year.



\_\_\_\_\_

Date

\_\_\_\_\_

Adult's Signature



## REQUIREMENT 6

“Be Careful With Fire” – determine the fire danger rating along your path.

The United States Department of Agriculture created the National Fire Danger Rating System. This system allows everyone to see the fire danger rating for today and tomorrow. There are five levels of fire danger: low, moderate, high, very high, and extreme.



To learn the fire danger in your local area, contact the agency responsible for maintaining the information in the area you will be visiting. Typically this is the United States Forest Service.

### **Fire Danger Level: Low**

When the fire danger is “low,” it means that fuels, like grass or wood, do not ignite easily from small embers, but a more intense heat source, such as lightning, may start fires in dry vegetation or dry rotten wood.

### **Fire Danger Level: Moderate**

When the fire danger is “moderate,” it means that fires can start from most accidental causes, but the number of fire starts is usually pretty low. Fires are still not likely to become serious and are often easy to control.

### **Fire Danger Level: High**

When the fire danger is “high,” fires can start easily from most causes, and small fuels (such as grasses and needles) will ignite

readily. Unattended campfires may escape their defined area, and brush fires are likely to quickly grow. Fires can become serious and difficult to control unless they are put out while they are still small.

**Fire Danger Level: Very High**

When the fire danger is “very high,” fires will start easily from most causes. The fires will spread rapidly and have a quick increase in intensity, right after ignition. Small fires can quickly become large fires and exhibit extreme fire intensity, such as long-distance spotting and fire whirls. These fires can be difficult to control and will often become much larger and longer-lasting fires.

**Fire Danger Level: Extreme**

When the fire danger is “extreme,” fires of all types start quickly and burn intensely. All fires are potentially serious and can spread very quickly with intense burning. Small fires become big fires much faster than at the “very high” level. Spot fires are probable, with long-distance spotting likely. These fires are very difficult to fight and may become very dangerous and often last for several days.



\_\_\_\_\_ **Date**

\_\_\_\_\_ **Adult's Signature**



## REQUIREMENT 7

**“Respect Wildlife” – from a safe distance, identify as you look up, down, and around you, six signs of any mammals, birds, insects, or reptiles.**

Most animals see humans as a threat and will hide when they see, hear, or smell humans. To increase your chances of seeing a wild animal, keep still for a long period of time without making any noise, even if you’re walking in your neighborhood or on a city path.



There are different types of animals. Mammals are animals that produce milk for their young and have an advanced brain, three middle ear bones, and fur or hair. Humans are mammals, and so are dogs and cats. The mammal that has the most species is the rodent. Rodents include rats, mice, and even beavers.

Birds are animals that have feathers, lay eggs, and have toothless beaked jaws. Birds come in many sizes, from the small hummingbird to the large ostrich. Note that for an animal to be a bird it does not need to fly. Birds like the ostrich and penguin are flightless birds.



Insects have an exoskeleton, which is a skeleton on the outside, like armor. They have a three-part body (head, thorax, and abdomen), three pairs of jointed legs, compound eyes, and one pair of antennae.

Insects are the most diverse group of animals; they include more

than a million described species and represent more than half of all known living things.

Reptiles include turtles, crocodylians, squamates (lizards and snakes), and even the tuatara – the only remaining reptile of its kind. There are about 11,700 species of reptiles. Reptiles are creatures that either have four limbs or, like snakes, are descended from four-limbed ancestors. They lay eggs that are surrounded by membranes for protection and transport. Reptiles range in size from a tiny gecko that is less than one inch long to the saltwater crocodile, which can reach almost 20 feet long.



Here are some ways to know if an animal is nearby or has been nearby:

- ▶ Listen for sounds. Not just the sound the animal would make, but also the sound of the animal moving.
- ▶ Look for where they live. A bird's nest, a burrow (hole in the ground), or a plant.
- ▶ Look for what they eat. Many animals eat plants, so you might see a bite mark on a leaf. Others might go through trash that has food in it.
- ▶ Look for scat (poop). Different animals leave different types of scat.
- ▶ Look for tracks. If it has rained recently and there is mud, you may see footprints that animals left behind as they walked.



\_\_\_\_\_

Date

\_\_\_\_\_

Adult's Signature



## REQUIREMENT 8

“Be Kind to Other Visitors” —  
identify what you need to do as a den  
to be kind to others on the path.



Being kind is part of the Scout Law, and when you're on your walk there are things you can do to be kind to others. According to the United States National Park Service, here are some good manners to use on your walk:

- ▶ Know your right of way. For example, you should walk on the right side of a path and not the left side. Check signs on the path and follow their directions.
- ▶ If you're on a trail or path that is wide enough for only one person and your den or family must walk single file, step aside and give space to anyone who is going uphill. If it's a flat area, be the first to step aside and give space for others to pass.
- ▶ Bicyclists yield to hikers.

- ▶ Be mindful of the plants or animals that are near the trail if you must step off the trail.
- ▶ Make yourself known. When you encounter other people, offer a friendly "hello." This helps create a friendly atmosphere on the path. If you approach another walker from behind, announce yourself in a friendly, calm tone and let them know you want to pass.
- ▶ Stay on the path or trail. Going off a trail or path can damage or kill certain plant or animal species and can hurt the ecosystems that surround the trail.
- ▶ Always practice Leave No Trace principles: Leave rocks, vegetation, and artifacts where you find them for others to enjoy.
- ▶ Do not disturb wildlife. They need their space, and you need yours, too. Keep your distance from any wildlife you encounter.
- ▶ Be mindful of the path or trail conditions. If a path or trail is too wet, muddy, or slippery, turn back and do the walk another day or find a different path.
- ▶ Take time to listen. Be respectful of both nature and the other users and keep the noise from electronic devices off.
- ▶ Be aware of your surroundings. It will help keep you and any members of your group safe. Know the rules for walking on your trail or path.



---

Date

---

Adult's Signature



## REQUIREMENT 9

Go on your one-mile walk while practicing your Leave No Trace Principles for Kids.



Now you are ready for your walk. One mile may go by fast. If you and your den or family want to walk longer, continue onward.

When you finish your walk, it's a good idea to talk to your den or family and share what everyone liked about it, what you would have done differently, and maybe even plan your next walk.



\_\_\_\_\_

Date

\_\_\_\_\_

Adult's Signature





# BEAR STRONG

PERSONAL FITNESS

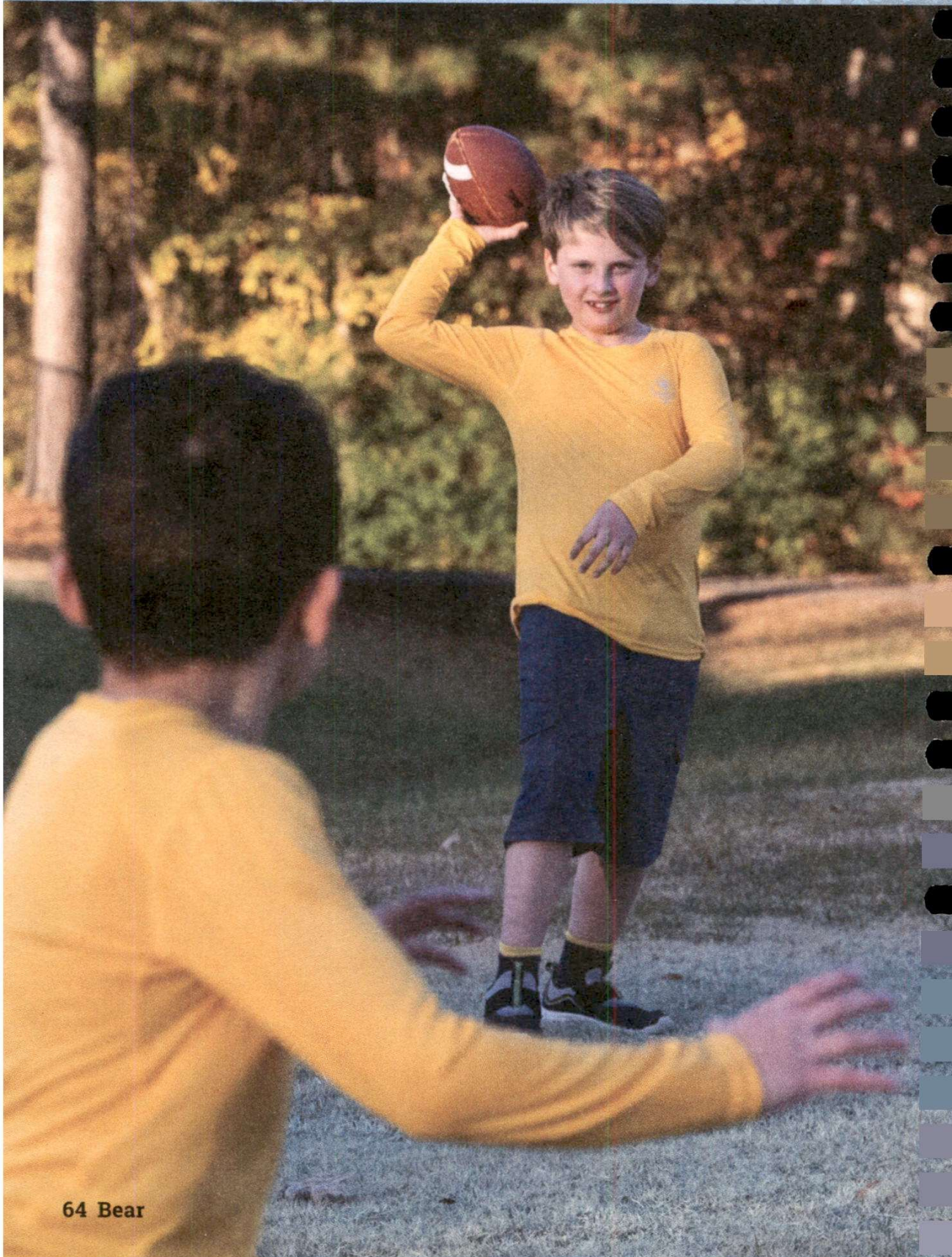



## SNAPSHOT OF ADVENTURE



In the Scout Oath, Cub Scouts promise to keep themselves physically strong and mentally awake. Personal fitness is about keeping your body strong by eating right and exercising, but it also means getting enough rest and exercising your mind by reading, solving problems, or even listening to music.

### REQUIREMENTS

1. Sample food from three of the following food groups: protein, vegetables, fruits, dairy, and grains.
2. Be active for 30 minutes with your den or at least one other person in a way that includes both stretching and moving.
3. Be active for 15 minutes by doing personal exercises that boost your heart rate, use your muscles, and work on flexibility.
4. Do a relaxing activity for 10 minutes.
5. Review your BSA Annual Health and Medical Record with your parent or legal guardian. Discuss your ability to participate in den and pack activities.



- [Required Adventure](#)
- [Scan for this Adventure page](#)



## REQUIREMENT 1

Sample food from three of the following food groups: protein, vegetables, fruits, dairy, and grains.



Proteins are essential nutrients for the human body. They help your body build muscles and provide your body with energy. Foods high in protein can come from animals or plants. Animal-based foods include meat, poultry, fish, and eggs. Plant-based foods high in protein include beans, grains, nuts, and seeds.

Vegetables are parts of plants that humans or other animals consume as food. Vegetables come in six different varieties.

- ▶ leafy green – lettuce and spinach
- ▶ cruciferous – cabbage, cauliflower, broccoli, and brussels sprouts
- ▶ marrow – pumpkin, cucumber, and zucchini
- ▶ root – potato, sweet potato, and yam
- ▶ edible plant stem – celery and asparagus
- ▶ allium – onion, garlic, and shallot

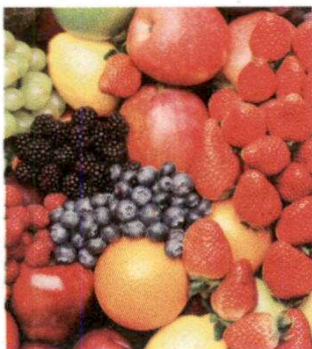

Fruits come from flowering plants. A flower will grow into a fruit, and inside the fruit are the seeds of that plant. The plant uses the fruits to attract animals to eat them, including the seeds. When the animal is done eating the fruit, the animal will scatter the seeds, and more plants will grow.

Fruits include apples, pears, watermelons, and even bananas. Have you noticed the tiny seeds in a banana? Fruits also include peppers and even tomatoes. Each of these developed from a flower, and they all have seeds, but we often refer to some of these as vegetables because of the way we eat or prepare them.

Dairy products or milk products are foods made from milk. Examples include yogurt, cheese, and butter. The most common mammals we get milk from are cows, but milk comes from all mammals. It is not hard to find dairy products made from goat or sheep milk.



Foods made from wheat, rice, oats, cornmeal, barley, or another cereal grain are grain products. Bread, pasta, breakfast cereals, grits, and tortillas are examples of grain products. Foods such as popcorn, rice, and oatmeal are also included in this food group.

Grains have two subgroups: whole grains and refined grains.

- ▶ Whole grains have the entire grain kernel, which includes the bran, germ, and endosperm. Some whole-grain examples are whole wheat flour, bulgur (cracked wheat), oatmeal, and brown rice.
- ▶ Refined grains have been milled, a process that removes the bran and germ. This is done to give grains a finer texture and improve their shelf life. But it also removes dietary fiber, iron, and many B vitamins. Some examples of refined grain products are white flour, corn grits, white bread, and white rice.



\_\_\_\_\_ Date

\_\_\_\_\_ Adult's Signature



## REQUIREMENT 2

Be active for 30 minutes with your den or at least one other person in a way that includes both stretching and moving.

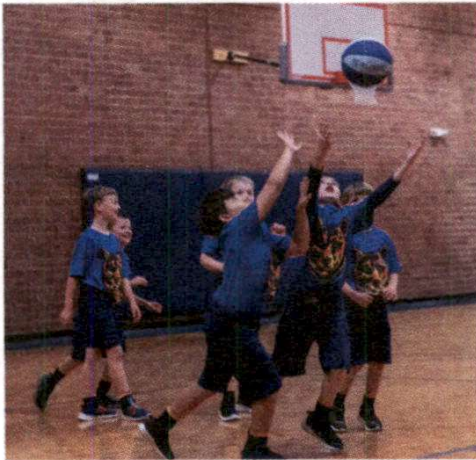

Being active with others is a great way to stay healthy. It is also fun to play with friends. To be active, you may pick a sport like soccer to play or maybe your den leader has a fun Cub Scout game for the den to play. While you're playing, remember that Scouts practice good sportsmanship whenever

we play together. Following the Scout Oath and the Scout Law as you play is called good sportsmanship.

Stretching can warm you up before exercising and cool you down afterward.

A 10-minute warm-up will get your heart ready for the activity. It will also loosen your muscles and help keep you from being injured. After you exercise, spend about 5-10 minutes cooling down. These slow exercises help lower your heart rate, keep your muscles from getting sore, and improve your flexibility.



Take time to warm up and cool down each time you exercise. Here are some warmup and cooldown stretches you can try:



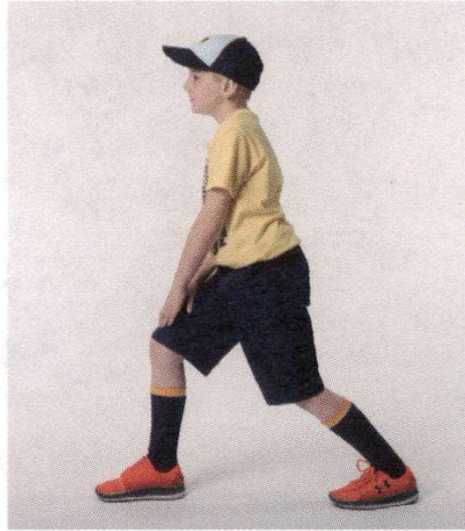

Date

Adult's Signature



## REQUIREMENT 3

Be active for 15 minutes by doing personal exercises that boost your heart rate, use your muscles, and work on flexibility.



Personal exercises include jumping jacks, sit-ups, pullups, jumping rope, or running in place. These are exercises you do on your own, but you don't have to do them alone. Your den could do jumping jacks together. Sometimes it is easier to do personal exercises with a group.

Some find it helps them to keep doing the exercises.

Remember to warm up before you begin and cool down when you're done.

You should do a personal exercise every day. If you want to see how personal exercise can make you stronger, track your progress. Write down how many sit-ups you can do, or see how long it takes you to walk one mile. Each time you do the activity, see if you're able to do more sit-ups or take less time to walk one mile.



\_\_\_\_\_

Date

\_\_\_\_\_

Adult's Signature

## REQUIREMENT 4

Do a relaxing activity for 10 minutes.

As you relax, you lower your heart rate, and your breathing slows down. This gives your body a chance to heal itself. Knowing how to lower your heart rate and slow down your breathing is also a good skill to help manage big feelings like anger, frustration, or stress.

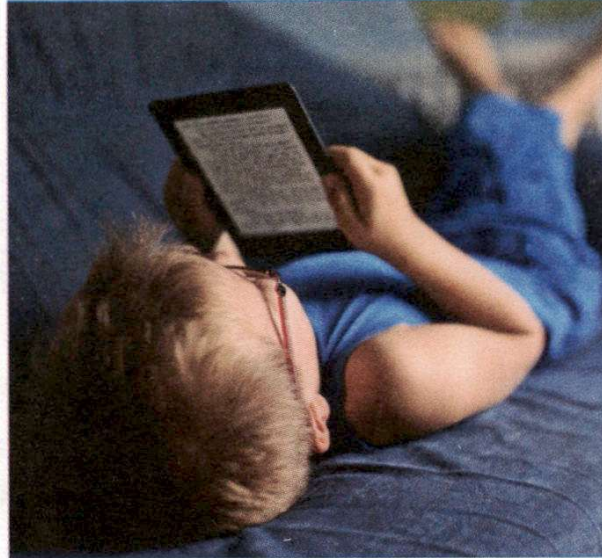

You may find doing something relaxing enjoyable and want to do it for more than 10 minutes. It may be something you try to do every day. Here are some things you may find relaxing:

- ▶ Listen to music.
- ▶ Learn how to do yoga.
- ▶ Read a book.
- ▶ Draw a picture.
- ▶ Work a puzzle.
- ▶ Do some breathing exercises.



\_\_\_\_\_

Date

\_\_\_\_\_

Adult's Signature



# REQUIREMENT 5

Review your BSA Annual Health and Medical Record with your parent or legal guardian.  
Discuss your ability to participate in den and pack activities.

Everyone who participates in a Cub Scout activity is required to have a BSA Annual Health and Medical Record on file with the pack. The adults in your pack can learn more about the BSA Annual Health and Medical Record on [scouting.org](http://scouting.org) or by scanning the QR code below.

Your parent or legal guardian will complete the BSA Annual Health and Medical Record for you. It does not require a doctor's appointment. The form asks for an emergency contact and collects basic information about you and your health history.

To get a copy of a BSA Annual Health and Medical Record, follow this QR code.

**Part A: Informed Consent, Release Agreement, and Authorization**

Full name: \_\_\_\_\_ High-Adventure Base participants:  
Date of birth: \_\_\_\_\_ Expedition or other activity: \_\_\_\_\_

**Witnessed Consent, Release Agreement, and Authorization**

I understand the responsibilities of participating in activities, including the risk of personal injury, including death, as in the physical, mental, and emotional challenges that are inherent in these activities. I have read and understand the information provided to me, including the BSA Code of Ethics, Safety Code of Conduct, and other information. I have read and understand the BSA Annual Health and Medical Record form and I understand that the information I provide on this form is for the use of the BSA and its members and is subject to the BSA's privacy policy. I understand that the information I provide on this form is for the use of the BSA and its members and is subject to the BSA's privacy policy. I understand that the information I provide on this form is for the use of the BSA and its members and is subject to the BSA's privacy policy.

**Parent or Legal Guardian Signature**  
Signature of parent or legal guardian: \_\_\_\_\_ Date: \_\_\_\_\_

**Participant Signature**  
Signature of participant: \_\_\_\_\_ Date: \_\_\_\_\_

**Complete this section for youth participants only:**

Adults Authorized to Sign Health and Fitness Events:  
Name: \_\_\_\_\_ Sex: \_\_\_\_\_  
Phone: \_\_\_\_\_ Email: \_\_\_\_\_

Adults NOT Authorized to Sign Health and Fitness Events:  
Name: \_\_\_\_\_ Sex: \_\_\_\_\_  
Phone: \_\_\_\_\_ Email: \_\_\_\_\_

Prepared For Life!



Is there something that your den leader should know about you that may help keep you safe? For example, are you allergic to certain foods, insect bites, medications, or latex? This information should be recorded on your BSA Annual Health and Medical Record.



---

Date

---

Adult's Signature



# PAWS FOR ACTION

## CITIZENSHIP





## SNAPSHOT OF ADVENTURE

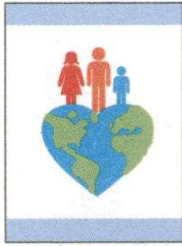

This Adventure is about America and the powerful symbols that represent the best of our country and how communities come together to help solve problems they are facing. Citizenship in America is about participation. One way to show citizenship is by making an impact locally through nonprofit organizations. Nonprofit organizations are a place for people to give their time, talents, and resources to make a difference in their community. You, too, can make an impact by participating in a service project that makes your community a better place.

### REQUIREMENTS

1. Familiarize yourself with the flag of the United States of America including the history, demonstrating how to raise and lower the flag, how to properly fold and display, and the United States flag etiquette.
2. Identify three symbols that represent the United States. Pick your favorite and make a model, work of art, or other craft that depicts the symbol.
3. Learn about the mission of any nonprofit. Find out how they fund their activities and how volunteers are used to help.
4. Participate in a service project.



- [Required Adventure](#)
- [Scan for this Adventure page](#)



## REQUIREMENT 1

Familiarize yourself with the flag of the United States of America including the history, demonstrating how to raise and lower the flag, how to properly fold and display, and the United States flag etiquette.

### History

The flag of the United States of America is very familiar. We see it at Cub Scout meetings, in school, in front of government buildings, and at sporting events. You could probably draw it from memory without much trouble. But the flag hasn't always looked like it does today. If a person from history, such as George Washington, saw today's flag, they would probably say there was something wrong with it.

Here are some of the flags that have flown over our country.

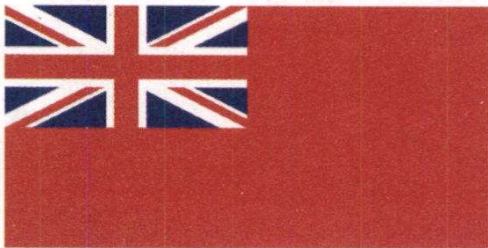

**British Red Ensign.** This ensign (another word for flag) flew over the American colonies before the American Revolution. It shows Great Britain's Union Flag of

1606, which combines the crosses of St. George (for England) and St. Andrew (for Scotland).

**Grand Union Flag.** George Washington flew this flag over his army headquarters near Boston, Massachusetts, in 1776, a year after the American Revolution began. This flag included 13 stripes representing the original 13 Colonies.

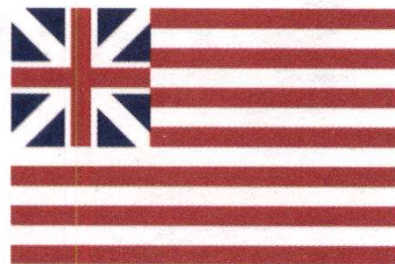



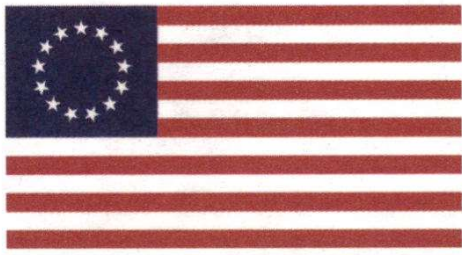

**Old Glory.** This is the first official flag of the United States. On June 14, 1777, the Continental Congress decided that the flag should have 13 stripes like the Grand Union Flag, along with a union of “thirteen stars, white in a blue field, representing a new constellation.” We celebrate June 14 as Flag Day each year.

**Star-Spangled Banner.** This flag includes 15 stripes and 15 stars because Vermont and Kentucky had joined the Union in the 1790s. It flew over Fort McHenry near Baltimore, Maryland, during the War of 1812 against Great Britain. Francis Scott Key watched it waving as the British bombarded the fort. Then he wrote our national anthem, “The Star-Spangled Banner.”

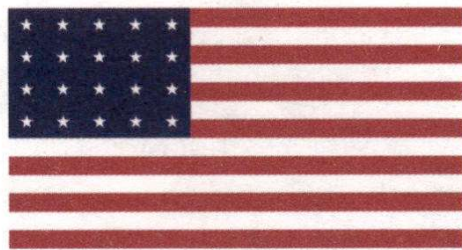
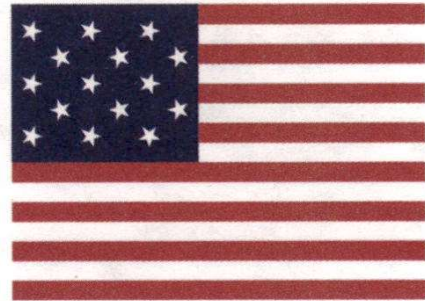

**Flag of 1818.** This flag has 20 stars but only 13 stripes. As more states joined the Union, people realized that the stripes were going to get too narrow. (Can you imagine 50 stripes on a flag?) Since 1818, all flags have included 13 stripes representing the original 13 Colonies and one star for each state.

**Today's Flag.** Here's the flag we use today. The most recent stars were added in 1959 (for Alaska) and 1960 (for Hawaii). This version of the flag has been in use longer than any other in our history.

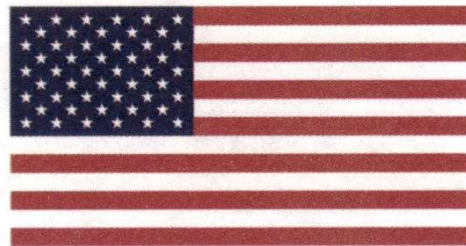



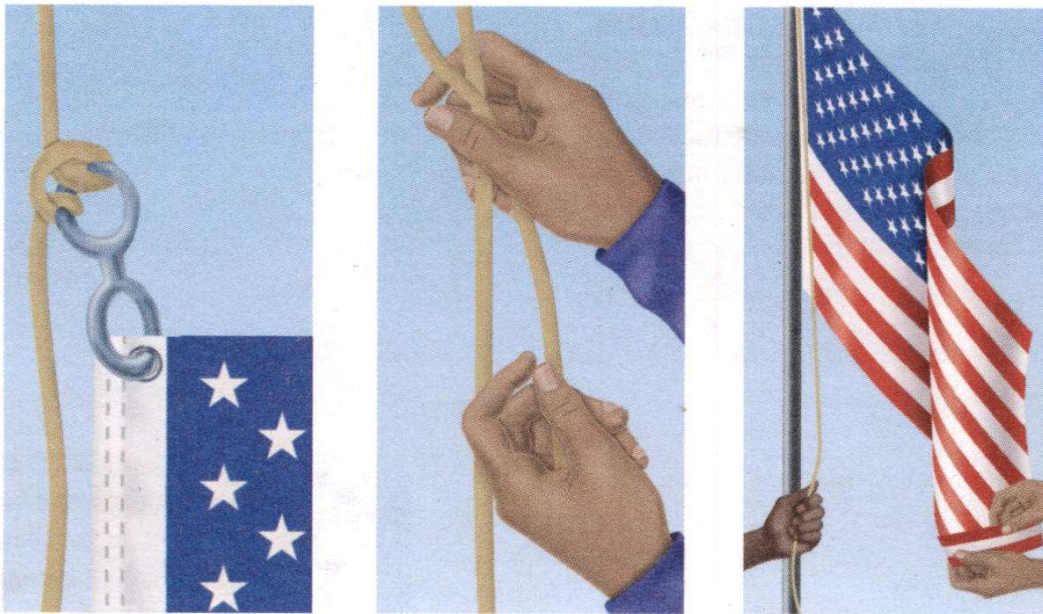

### **Raising and Lowering the Flag**

It takes two people to raise and lower the flag correctly. The first person holds the flag. The second person attaches it to the halyard (rope) and raises it, keeping it close to the pole by holding the halyard tight. Then, they fasten the halyard to the cleat on the pole. (Make sure it's snug so the flag stays at the top.) The flag should be raised quickly in the morning and lowered slowly in the evening.

The president, a governor, or the mayor of the District of Columbia can order the flag to be flown at half-staff to represent the nation in mourning. When the flag is going to be flown at half-staff, the flag should be raised to full-staff and then lowered to half-staff. When it's time to retrieve the flag, it should be raised to full-staff before it is lowered.

## Folding the Flag

The United States flag is folded in a special way until only the blue field shows. First, fold the flag lengthwise in half, then lengthwise again with the blue field on the outside. (It can help to have a third person support the middle of the flag.) Next, make tight triangular folds, starting from the striped end, until only the blue field is showing. Tuck in the loose end.

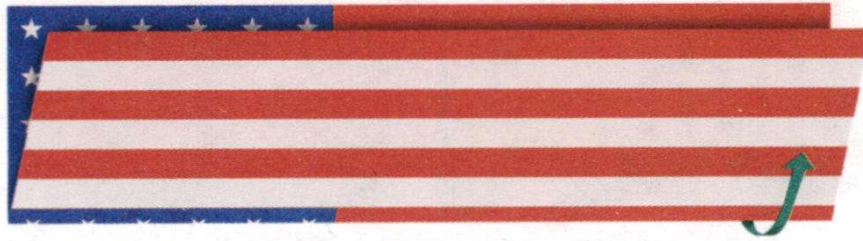

(A) Straighten out the flag to full length and fold lengthwise once.



(B) Fold it lengthwise a second time to meet the open edge, making sure that the union of stars on the blue field remains outward in full view. (A large flag may have to be folded lengthwise a third time.)



(C) A triangular fold is then started by bringing the striped corner of the folded edge to the open edge.



(D) The outer point is then turned inward, parallel with the open edge, to form a second triangle.



(E) The diagonal or triangular folding is continued toward the blue union until the end is reached, with only the blue showing and the form being that of a cocked (three-corner) hat.





### **Displaying the Flag**

When the United States flag is displayed flat on a wall, the stars should always be up and to the left (the flag's right). When the flag is on a stage, it should be on the speaker's right. When it is in the audience, it should be on the audience's right. When the flag is displayed with other flags, like state flags, it should be higher than the others. When it is flown

with flags of other nations, all the flags should be at the same height, but the United States flag should be on its own right.

### **Retiring the Flag**

When a United States flag becomes worn beyond repair, it should be retired by burning it completely to ash. This should be done in a simple manner with dignity and respect. Your den or pack may do this as part of a ceremony, but your family could do this as well. Be very careful when retiring a flag so you don't injure yourself, especially if the flag is made of synthetic material. Melting nylon can cause serious burns if you let it touch your skin.

### **Flag Etiquette**

The guidelines for displaying the United States flag are part of something called the United States Code. You can learn more about it, with permission, online at [usflag.org](http://usflag.org).



The flag should be treated with courtesy and respect. There are some basic rules every person should know:

- ▶ The flag should only be flown from dawn to dusk unless it's illuminated by a light.
- ▶ The flag should only be flown in nice weather unless it's made of all-weather material.
- ▶ You can print out a picture of a flag to display or post a fabric flag outside your home.
- ▶ The flag can be displayed every day. Special days to display the flag are holidays like Memorial Day (the last Monday in May), Flag Day (June 14), and Independence Day (July 4).
- ▶ The flag should be kept clean, so try not to let it touch the ground. If it does touch the ground, however, it can still be used. If it gets dirty or torn, it's OK to clean and mend it.
- ▶ If the flag becomes so dirty, torn, or faded that it can't be used anymore, it should be retired by burning it in a dignified manner.
- ▶ If you're in uniform, give the Cub Scout salute when the flag passes in a parade, when it is being raised or lowered, or when you're saying the Pledge of Allegiance. If you're not in your Cub Scout uniform, hold your right hand over your heart at those times.



---

Date

Adult's Signature



## REQUIREMENT 2

Identify three symbols that represent the United States. Pick your favorite and make a model, work of art, or other craft that depicts the symbol.

A symbol is a mark, sign, or word that represents an idea, object, or relationship. We see symbols all the time like the triangle used to represent play on a video, the two parallel lines that represent pause, and the square that represents stop.

Symbols can also represent an idea like freedom, bravery, strength, or liberty. These symbols remind us of these ideals just like the Cub Scout sign reminds you to live and act by the Scout Oath and the Scout Law.



### **The United States Flag**

You learned about the United States flag in requirement 1 and from that you understand the symbols of the flag – the stars and the stripes.

### **The Statue of Liberty**

This is a symbol of freedom and was a gift to the United States from France. The torch is a symbol of enlightenment. The Statue of Liberty's torch lights the way to freedom, showing us the path to liberty. Even the statue's official name represents her most important symbol "Liberty Enlightening the World."



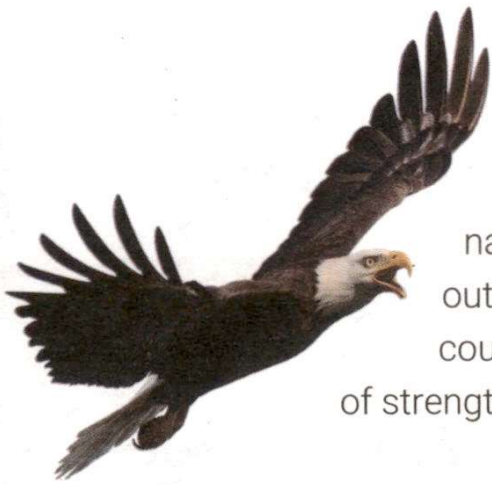

### **Bald Eagle**

The bald eagle is the United States' national bird. It was first placed with outspread wings on the Great Seal of our country. Many see the bald eagle as a symbol of strength, courage, freedom, and immortality.

### **Liberty Bell**

The Liberty Bell bears a timeless message: "Proclaim LIBERTY Throughout All the Land Unto All the Inhabitants thereof." The bell was originally used as a way

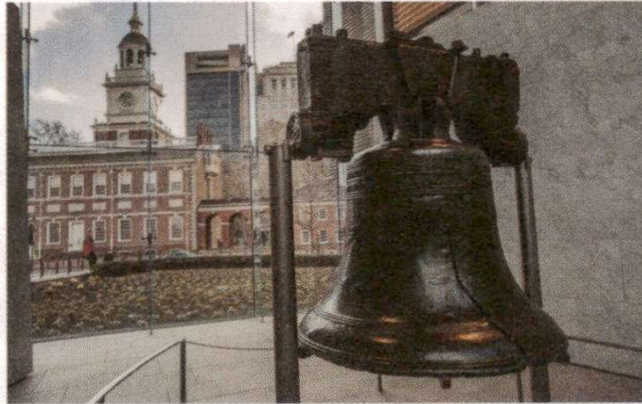

to let people know it was time to hear the news being read in the town center and as a way to let lawmakers know it was time to meet. Now it serves as a symbol of liberty.



### **The Rose**

One of the newest symbols of the United States is the rose. In 1986 the rose became the official flower of the United States as a symbol of love and beauty.



\_\_\_\_\_ **Date**

\_\_\_\_\_ **Adult's Signature**



## REQUIREMENT 3

Learn about the mission of any nonprofit.  
Find out how they fund their activities and how  
volunteers are used to help.



Most businesses, like a restaurant or a store, have the goal to make money by selling things. Nonprofits are organizations that do not have a goal to make money, but instead have a different goal or mission.

Nonprofits have a mission or a purpose that focuses on trying to solve a problem in a community. For example, the adults in a family may have lost their jobs and now need help to buy food or pay for their housing, or they may need to learn new skills to get a new job. A nonprofit may be formed to help with one or all of these problems.

Nonprofits may also have a mission to keep problems in a community from happening. The BSA, which includes Cub

Scouting, is a national nonprofit. There is a local nonprofit for the BSA called a council. Being a Cub Scout means you're also part of a nonprofit.

To deliver a mission or goal, a nonprofit requires resources. Resources are the things that are needed for an organization to function. For example, if a nonprofit wants to help feed people who need food, a resource they need would be food. Other resources they would need are a place to serve the food, people to prepare and serve the food, and a way to let those who need food know that they can come and get help.

A frequent resource that a nonprofit may need is volunteers. A volunteer is someone who gives their time and their abilities without payment. Volunteers allow nonprofits to do things that could never be done without them. Volunteers make our communities and our country better. Your den leader is a volunteer. They give of their time so you can be a Cub Scout.



\_\_\_\_\_

Date

\_\_\_\_\_

Adult's Signature



# REQUIREMENT 4

Participate in a service project.



In requirement 3 you learned about nonprofit organizations. Perhaps there is something your den or pack can do to help one as a service project. A service project is a chance for you to volunteer and give of your time and abilities to make your community and country better.

Here are some other service projects you may want to do.

- ▶ With your family, plant a tree, wildflowers, or native plants in a place designated in your community.
- ▶ With your den, collect old eyeglasses or shoes, and donate them to an organization that recycles the items for those in need.
- ▶ With your pack, organize a Toys for Tots drive with the United States Marine Corps Reserve.



Date

Adult's Signature





# STANDING TALL

PERSONAL SAFETY AWARENESS





## SNAPSHOT OF ADVENTURE



In this Adventure, the Protect Yourself Rules will give you guidance on keeping yourself safe. You will also identify ways to use electronics responsibly and ways to protect your body when you're playing or working. When bears feel they are in danger, they may stand on their back legs, standing tall, to let the danger know that they are brave and know how to keep themselves safe.

### REQUIREMENTS

1. With permission from your parent or legal guardian, watch the "Protect Yourself Rules" video for the Bear rank.
2. Complete the Personal Space Bubble worksheet that is part of the Protect Yourself Rules resources.
3. With your parent or legal guardian, set up a family policy for digital devices.
4. Identify common personal safety gear for your head, eyes, mouth and nose, hands, and feet. List how each of these items protect you. Demonstrate the proper use of personal safety gear for an activity.



- [Required Adventure](#)
- [Scan for this Adventure page](#)



# REQUIREMENT 1

With permission from your parent or legal guardian, watch the "Protect Yourself Rules" video for the Bear rank.

In the "Protect Yourself Rules" video, you will meet Sara and Lenny, who are Cub Scouts just like you. They will guide you through the six Protect Yourself Rules.



To watch the video, go to [scouting.org](http://scouting.org) or follow this QR code.



\_\_\_\_\_ Date

\_\_\_\_\_ Adult's Signature

## REQUIREMENT 2

Complete the Personal Space Bubble worksheet that is part of the Protect Yourself Rules resources.

Everyone feels more comfortable with people they know well.

There are some people we are comfortable with, and we allow them to be physically closer to us. Our personal space bubble helps us identify

those we are comfortable with being physically close to us and those who we may not know as well or not know at all and the distance we want them to stay from us.

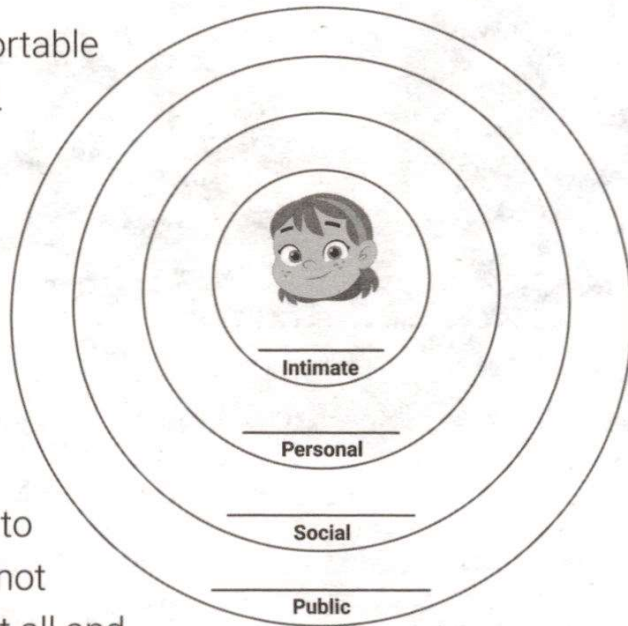

- ▶ The space directly around us is our intimate space. This space is just for us, although we may also allow family in this space.
- ▶ Next is our personal space, which goes all around us as far as the ends of our outstretched fingertips. We are usually comfortable with friends and family in this space.
- ▶ After that is social space. We're most comfortable hanging out with friends or talking in groups in this space.
- ▶ Last is public space, which is where we're most comfortable with strangers or people out in public.



\_\_\_\_\_ Date

\_\_\_\_\_ Adult's Signature



## REQUIREMENT 3

With your parent or legal guardian, set up a family policy for digital devices.



With your parent or legal guardian, take a look around where you live and identify the digital devices that are part of your home. These may be toys or

devices that you have permission to use. When setting a family policy, here are some things to consider:

- ▶ How early in the day will you be allowed to use the device?
- ▶ How late will you be allowed to use the device?
- ▶ Will these times be different on weekdays, weekends, or during school breaks?
- ▶ Does the device have access to the internet? Are there content controls in place?
- ▶ Are there age restrictions to content on electronic devices?
- ▶ Where should the device(s) be stored when not being used?
- ▶ Are there responsibilities that need to be completed before using the device(s), such as homework or chores?
- ▶ What happens when the policies are followed?
- ▶ What happens when the policies are not followed?



\_\_\_\_\_ Date

\_\_\_\_\_ Adult's Signature

## REQUIREMENT 4

Identify common personal safety gear for your head, eyes, mouth and nose, hands, and feet.

List how each of these items protects you.

Demonstrate the proper use of personal safety gear for an activity.

Safety gear is designed to keep you safe while playing a sport, riding a bike, or building a project. Always use the appropriate safety gear for each activity. Here are some examples to think about. Before doing an activity, discuss with your parent or another adult what type of safety equipment you should use. Always use gear that is designed for the activity and fits you correctly.

### Head

Helmets are designed to protect your head. You should wear a helmet when there is a chance that you could fall down or something may fall down on you. If your head gets hit by something hard, it may injure your brain or fracture (break) your skull. Wearing a helmet greatly reduces the chances of serious brain injury or damage to your skull.

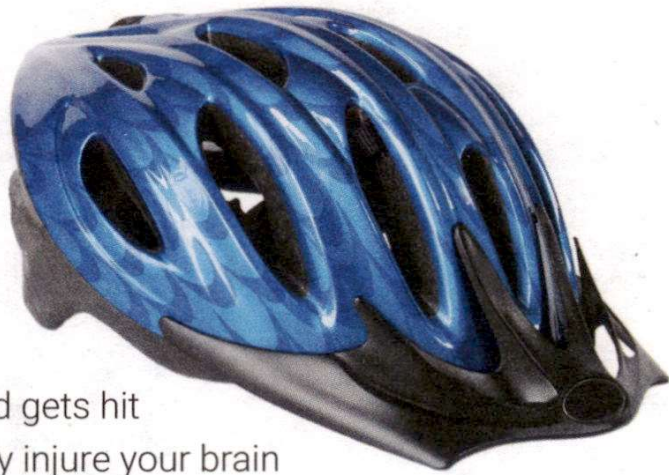

### Eyes

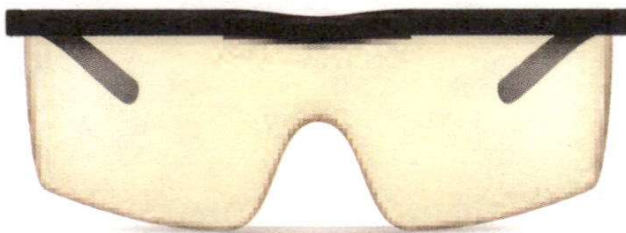

Safety goggles and glasses protect your eyes from flying objects. Glasses designed to help you see are not designed



to protect your eyes. You need to wear goggles or glasses that are specifically designed to protect your eyes. In some circumstances, you might even wear a face mask.

Sunglasses are another form of safety gear for your eyes. The sun can damage your eyes and make it hard to see. Sunglasses block out ultraviolet rays and reduce the damage the sun can cause to your eyes.



### **Mouth and Nose**

Wearing a mask that covers your mouth and nose and still allows you to breathe can protect you from diseases, things that smell bad, and fumes that may cause you to feel ill. When properly worn, masks filter out things that are so small you can see them only with a microscope.

### **Hands**

Gloves can keep your hands warm on a cold day and prevent frostbite. Work gloves protect your hands from plants that may irritate your skin or that have sharp thorns or needles. They can also prevent your hands from getting blisters when using hand tools.





Latex gloves or nitrile (an alternative to latex) gloves can protect your hands when using chemicals that can irritate, damage, or stain your skin. They can also be used to keep your hands clean, like when painting.

### Feet

Shoes are the most common form of foot protection. Not all shoes can protect your feet, though.

Remember to wear the right shoes for the activity. If you're going to walk on a path that has loose rocks, you want to have boots that have sturdy soles to protect the bottoms of your feet.

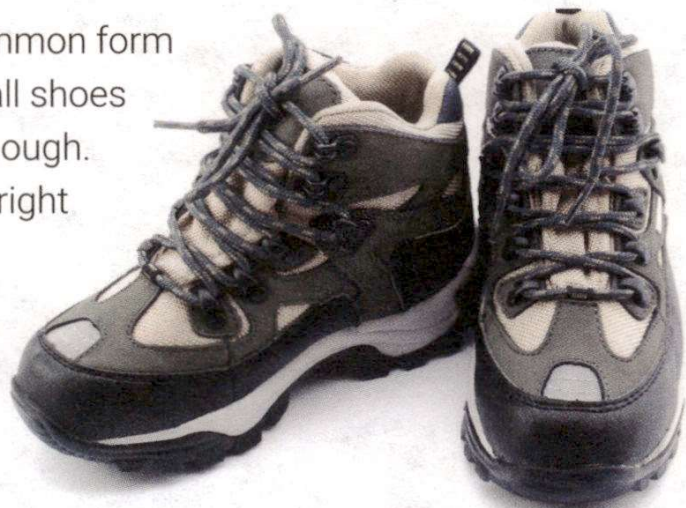

\_\_\_\_\_

Date

\_\_\_\_\_

Adult's Signature



# FELLOWSHIP

## FAMILY & REVERENCE



- Required Adventure
- Scan for this Adventure page



## SNAPSHOT OF ADVENTURE



In this Adventure, you're encouraged to learn more about your family's faith traditions. You will complete most of these requirements at home with your family. Faith means having complete trust or confidence in someone or something. Always be respectful when talking about your faith and when learning about other faiths.

You may earn this Adventure by either completing the requirements below or earning the religious emblem of your choosing. To learn more about available religious emblems, visit [scouting.org](https://scouting.org) or scan this QR code.



### REQUIREMENTS

1. With your parent or legal guardian, talk about your family's faith traditions. Identify three holidays or celebrations that are part of your family's faith traditions. Make a craft, work of art, or a food item that is part of your favorite family faith tradition holiday or celebration.
2. With your family, attend a religious service OR other gathering that shows how your family expresses reverence.
3. Carry out an act of kindness.
4. With your parent or legal guardian, identify a religion or faith that is different from your own. Determine two things that it has in common with your family's beliefs.



## REQUIREMENT 1

With your parent or legal guardian, talk about your family's faith traditions. Identify three holidays or celebrations that are part of your family's faith traditions. Make a craft, work of art, or a food item that is part of your favorite family faith tradition holiday or celebration.



Food is a common part of faith traditions, holidays, and celebrations. For some faiths, it is an everyday practice in which only certain foods are to be eaten. There are also times when the food

you eat is a way your family celebrates or honors your faith. For some families, making tamales with their family is a Christmas tradition. For others, it may be making latkes (potato pancakes) for Hanukkah or coloring eggs during Easter.

What are some of the things that your family does as part of your faith traditions?

What are some things that your family does to celebrate or practice your faith?



Date

Adult's Signature



## REQUIREMENT 2

With your family, attend a religious service or other gathering that shows how your family expresses reverence.

With a member of your family or with your whole family you may decide to attend a religious service. The service can be of your own faith or a faith that you're interested in learning more about.

You may choose to attend a gathering where everyone is expected to show reverence. This may be a gathering of several different faiths in support of a community project or an event such as placing flags on the graves of veterans during Memorial Day.



\_\_\_\_\_

Date

\_\_\_\_\_

Adult's Signature



## REQUIREMENT 3

Carry out an act of kindness.

Being kind to someone is an action. There are many ways to show kindness, and often they are simple things. When you are friendly and you make sure not to make someone feel bad, you're being kind. Other examples of being kind include doing something special for someone like making a birthday card for them or being friendly to a new student at school.

Can you think of a time when someone was kind to you? How did that make you feel? When you're being kind to someone else, you're probably giving them that same good feeling you had when someone was kind to you.



\_\_\_\_\_

Date

\_\_\_\_\_

Adult's Signature

## REQUIREMENT 4

With your parent or legal guardian, identify a religion or faith that is different from your own. Determine two things that it has in common with your family's beliefs.

At first, you may think that when you meet someone from another part of the world you have nothing in common. You may speak different languages, eat different foods, and even dress differently. Once you learn how to communicate with them, you may discover that they like to play soccer just like you, but maybe they call it football. You may find out that they, too, are a Cub Scout and have a similar Scout Oath and Scout Law.

When looking for things that you have in common, it may be something simple like having a building where you pray. This building may use different names, such as church, mosque, or temple.

You may find that you have similar beliefs, such as that people should be kind to each other or that family is important. Look for at least two things that you have in common.



\_\_\_\_\_

Date

\_\_\_\_\_

Adult's Signature



# A BEAR GOES FISHING

ELECTIVE ADVENTURE





## SNAPSHOT OF ADVENTURE



Grizzly bears in the wild use their fishing skills to catch good, nutritious food. After you complete this Adventure, you'll be able to do the same thing. You won't have to use your paws and teeth, however.

Instead, you'll use a cane pole or a rod and reel.

You'll also learn about the fish that live nearby and the rules that must be followed when fishing. And who knows? You may discover a hobby that you can enjoy for years to come. So grab your tackle, and let's go fishing!

### REQUIREMENTS

1. Learn about three types of fish in your area.
2. Learn about your local fishing regulations with your den leader or another adult.
3. List three of the regulations you learned about and one reason each regulation exists.
4. Become familiar with the safe use of the fishing equipment you use on your outing.
5. Learn the proper way to attach the hook, lure, or fly to the line.
6. Go on a fishing adventure, and for 30 minutes or more, put into practice the things you have learned about fish and fishing equipment.



- [Elective Adventure](#)
- [Scan for this Adventure page](#)



## REQUIREMENT 1

Learn about three types of fish in your area.

Fish can be picky eaters. What they like to eat changes based on what is available. One day they may want smaller fish; other days they may want a bug. Some species of fish will eat just about anything.

Some fish like cold water; others like warm water. Fish live in most waters, including fresh water (inland lakes, ponds, streams, and rivers); others live in salt water (oceans and shoreline areas). Some types of fish like to hide in underwater brush piles; others like to swim in open water.

Before you go fishing, it's important to know about the fish that live in your area. Learn about three fish species that live in your local waters. Record what you discovered on these pages.

You can find links to state fish and wildlife agencies on the internet (with permission) at [www.fws.gov/offices/](http://www.fws.gov/offices/).



You can learn about fish species at your school or local library or on the internet with the help of your parent or legal guardian. Your state has a government agency that takes care of the fish population. It can be a good source for information about fish species.

Some communities have fish hatcheries (places that hatch fish eggs and grow fish) that you can tour and where you can learn about fish. Other good sources of information are local fishing clubs and stores that sell fishing equipment and bait.

## FISH IN MY AREA

**Fish Species 1:** \_\_\_\_\_

Looks Like: \_\_\_\_\_

Likes to Eat: \_\_\_\_\_

Habitat: \_\_\_\_\_

Average weight: \_\_\_\_\_

**Fish Species 2:** \_\_\_\_\_

Looks Like: \_\_\_\_\_

Likes to Eat: \_\_\_\_\_

Habitat: \_\_\_\_\_

Average weight: \_\_\_\_\_

**Fish Species 3:** \_\_\_\_\_

Looks Like: \_\_\_\_\_

Likes to Eat: \_\_\_\_\_

Habitat: \_\_\_\_\_

Average weight: \_\_\_\_\_



\_\_\_\_\_ Date

\_\_\_\_\_ Adult's Signature



## REQUIREMENT 2

Learn about your local fishing regulations with your den leader or another adult.

There are rules and regulations to follow when fishing. These are important because they help protect the fish and their environment. It is important that you learn these rules, understand what they mean, and promise to follow them.

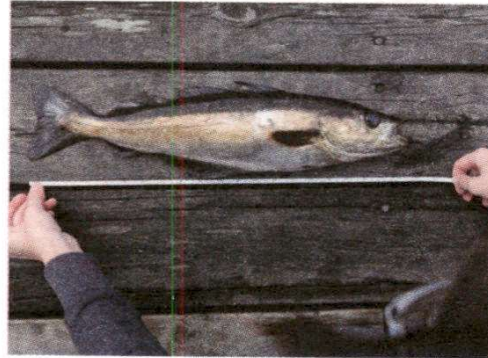

Your local area may have rules about where and when you can fish, how big a fish must be to keep, and how many fish you're allowed to keep. In some places, you must put the fish you catch back in the water. This practice is called catch and release. It is a good way to make sure fish continue to live in the place you're fishing.



In addition to rules about fishing, your state will also require a fishing license. Adults must purchase a fishing license before they go fishing. Youth who are Cub Scout age often don't have to have a license. Be sure to find out about licensing requirements in your area.

Once you know your local fishing rules and regulations, here are the six things to know to keep yourself and others safe:

1. Fish with proper adult supervision.
2. Get permission to fish where you plan to fish.
3. Check the weather before you go. Do not fish in a thunderstorm or inclement weather.
4. Use the buddy system. You must be able to see your buddy.
5. Give plenty of room to others who are fishing nearby.
6. Never fish where people are swimming.

Be sure to discuss any other rules your family has so you'll be safe while fishing.

**Fishing tips:**

- ▶ When you are through fishing, properly dispose of your worms or bait fish. Do not release them into the water.
- ▶ If releasing your catch, always wet your hands prior to touching a fish to protect the mucous membrane that protects the fish.
- ▶ To release fish easily, bend down all barbs on hooks.
- ▶ Treble hooks are not recommended.



\_\_\_\_\_ Date

\_\_\_\_\_ Adult's Signature



# REQUIREMENT 3

List three of the regulations you learned about and one reason each regulation exists.

## FISHING REGULATIONS

**Fishing Regulation 1:** \_\_\_\_\_

This regulation is important because \_\_\_\_\_

**Fishing Regulation 2:** \_\_\_\_\_

This regulation is important because \_\_\_\_\_

**Fishing Regulation 3:** \_\_\_\_\_

This regulation is important because \_\_\_\_\_



\_\_\_\_\_ Date

\_\_\_\_\_ Adult's Signature

## REQUIREMENT 4

Become familiar with the safe use of the fishing equipment you will use on your outing.

It's fun to fish with a simple fishing pole, but most people use a rod and reel instead. A rod and reel will allow you to cast your line farther out into the water. And when you hook a fish, it's easier to reel it in.

### ROD

The rod takes the place of the fishing pole. A rod has line guides (metal rings) along its length that the fishing line runs through. Most rods are made of fiberglass or carbon fiber. Some rods come apart so you can transport them easily. These are called take-down rods.

The weight of rods varies. To catch small fish, you could use an ultralight rod. To catch fish like trout, you could use a long, thin, lightweight rod called a fly rod. For bigger fish, you would need a rod that is thicker and stronger. If you were going surf fishing, you might use a rod that's 20 feet long!





## REEL

The reel is attached to the rod near its handle. Inside the reel is a spool that your fishing line wraps around (and around and around and around). From the reel, the end of the line goes up the rod through the guides before you attach your hook or lure. To reel in the line, you turn the reel. When casting (tossing your line out on the water), you release a trigger on the reel, which lets the fishing line go.



There are many types of reels. If you're new to fishing, you might want to pick a close-faced spincast reel that has a cover to protect the line inside. When casting with a spincast reel, you press and hold the button on top of the reel. During the cast, you release the button to let the line out and complete the cast. The timing can be tricky, but you'll soon figure it out.

Open-faced spincasting reels don't have a cover and take more skill to use. Without practice, you can end up with something called a "bird's nest": a big, knotted wad of fishing line that is no longer usable.



## FISHING LINE

There are many types and colors of fishing line. Some line is meant to catch fish that weigh less than a pound. Some is meant to catch fish that weigh 10, 20, or even 50 or more pounds. Be sure to use line that is strong enough for the fish you want to catch. Otherwise, a fish can break the line and get away.

Fishing line may be clear or have a tint, like green or bronze. Like camouflage, the tinted fishing line blends into its surroundings and makes a good choice for fishing when looking to keep your line invisible to fish. A tinted fishing line may be more visible to you than clear fishing line in very clear water.



## BAIT

You will also need to have the correct bait for the type of fish you're fishing for. If the fish don't like to eat the bait you're using, they won't bite. Do you remember what you learned in requirement 1 about the fish in your area? You will have better luck catching a fish if you use bait that the fish would naturally eat.

You will need to decide if you want to use live bait like minnows, worms, or grubs or use artificial bait. There are many types of artificial bait. Some make noise in the water or spin around to attract fish. Some are designed to look like live bait. There are special dough baits that you can form around the hook. These have scents that attract fish.







## **TACKLE BOX**

A tackle box is a good place to store your bait and other fishing supplies (called tackle) while you're traveling and while you're fishing. It keeps your tackle clean and organized. You can buy a tackle box at a store or reuse something you find around your home. Be sure there is a way to secure the lid so it doesn't open at the wrong time.

**Here are some things to carry in your tackle box:**

- ▶ **Artificial bait** to catch fish.
- ▶ **Barbless hooks** cause less harm to a fish's mouth when you're practicing catch-and-release fishing. If you cannot find barbless hooks, you can use pliers to flatten the barbs on barbed hooks.
- ▶ **Bobbers** are small floats that attach to your fishing line. They keep your hook at a certain depth and show when a fish bites.
- ▶ **Sinkers** are weights attached to your fishing line about 6-10 inches above the hook. They let you fish lower in the water because they pull down on the hook. This keeps your bait down near the lake or river bottom where most fish swim. For most shore fishing, pinch one or two small split-shot sinkers onto your line. Use only enough weight to sink the bait.
- ▶ **Clippers** let you cut off the fishing line after you tie it on a hook.
- ▶ **Dehookers** are used to remove hooks safely and quickly from a fish who swallows them.
- ▶ **Needle-nose pliers** help you remove hooks from fish and pull knots tight.



---

Date

Adult's Signature



## REQUIREMENT 5

Learn the proper way to attach the hook, lure, or fly to the line.

### FISHING KNOTS

You must know the proper types of knots for tying hooks to your line. Because fishing line is stiff and slippery, you can't just use any knot. You need a knot that will jam against itself and hold tight. Here are two good knots to learn.

#### Improved clinch knot.

1. Run the end of the line through the eye of the hook, double the line back, and make six twists around the standing part (the long part of the line).
2. Run the end of the line through the small loop where the line joins the eye and then back through the large loop you just formed.
3. Partially close the knot and moisten it a little with water before securing it tightly against the hook eye. Cut off the short (tag) end of the line.

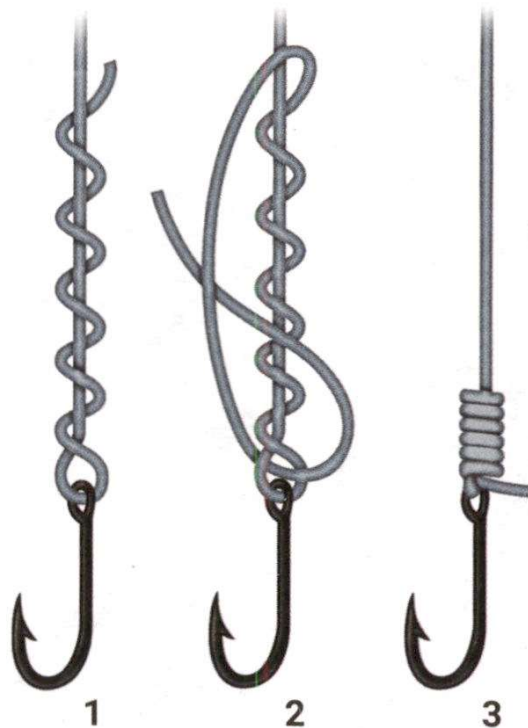

## Palomar knot.

1. Double the line to make a 4- to 6-inch loop, then pass the end of the loop through the eye. (You may need to crimp the end of the loop so it will go through the eye.)
2. Tie a loose overhand knot in the doubled line.
3. Pass the hook through the loop and pull on the doubled line to tighten the knot, guiding the loop over the top of the eye.
4. Cut off the short (tag) end of the line.

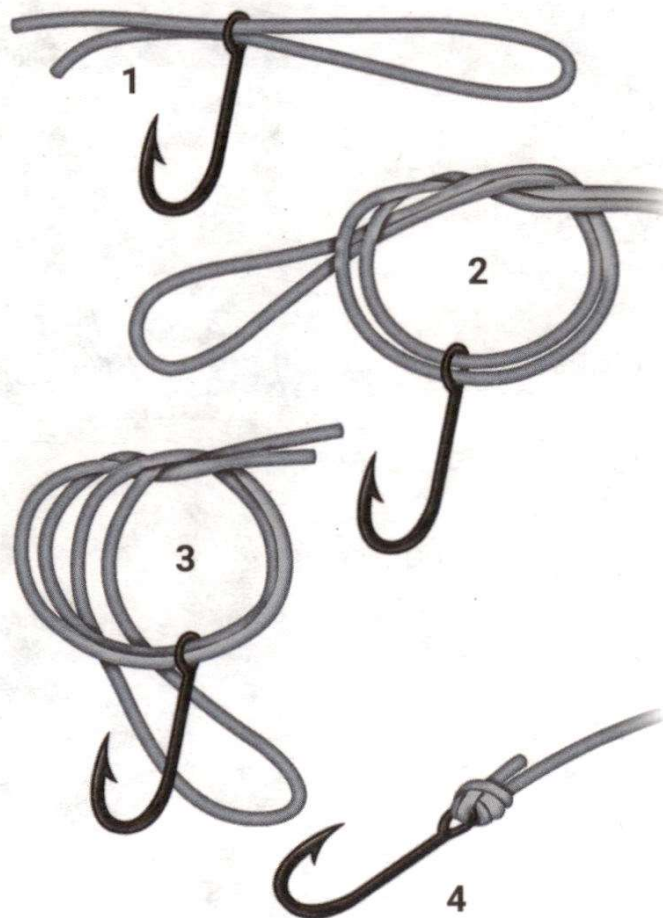

Date \_\_\_\_\_

Adult's Signature \_\_\_\_\_



## REQUIREMENT 6

Go on a fishing adventure, and for 30 minutes or more, put into practice the things you have learned about fish and fishing equipment.

It is fun to practice casting and to pick out fishing gear, but the real fun happens when you actually go fishing. It will be exciting to see your bobber disappear under the water or feel the pull on your line as you reel in a fish for the first time. For many people that excitement never goes away, no matter how many fish they catch.

To practice casting, you'll need a rod with a reel attached. Instead of using a hook, tie a casting plug or bobber to your line so it will be heavy enough to cast. Place a target, and practice hitting the target with the casting plug or bobber. Do this until you can get closer to the target than you were at first. As your accuracy improves, move farther from the target. The time you spend practicing will help make fishing safe and fun.

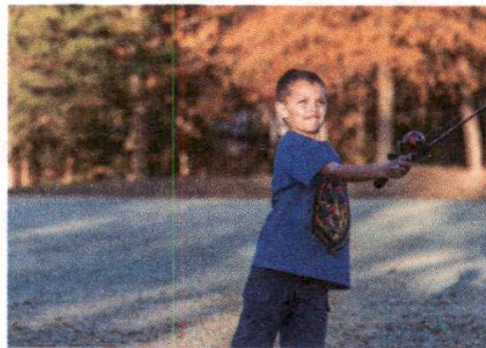
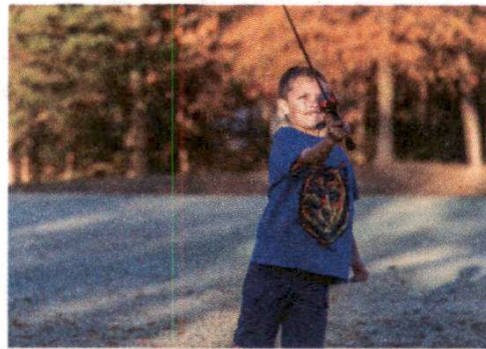
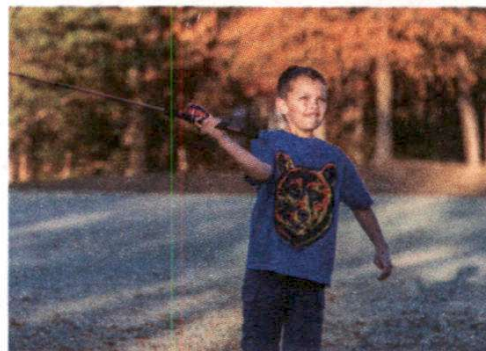



Make a plan with your den, your pack, or your family for where and when you'll go fishing. Spend a minimum of 30 minutes trying to catch a fish. Remember all the things you have learned about fish, fishing equipment, and the rules of fishing. And remember that a Scout is cheerful — even if you don't catch a fish.



\_\_\_\_\_

Date

\_\_\_\_\_

Adult's Signature





# BALANCING BEARS

ELECTIVE ADVENTURE

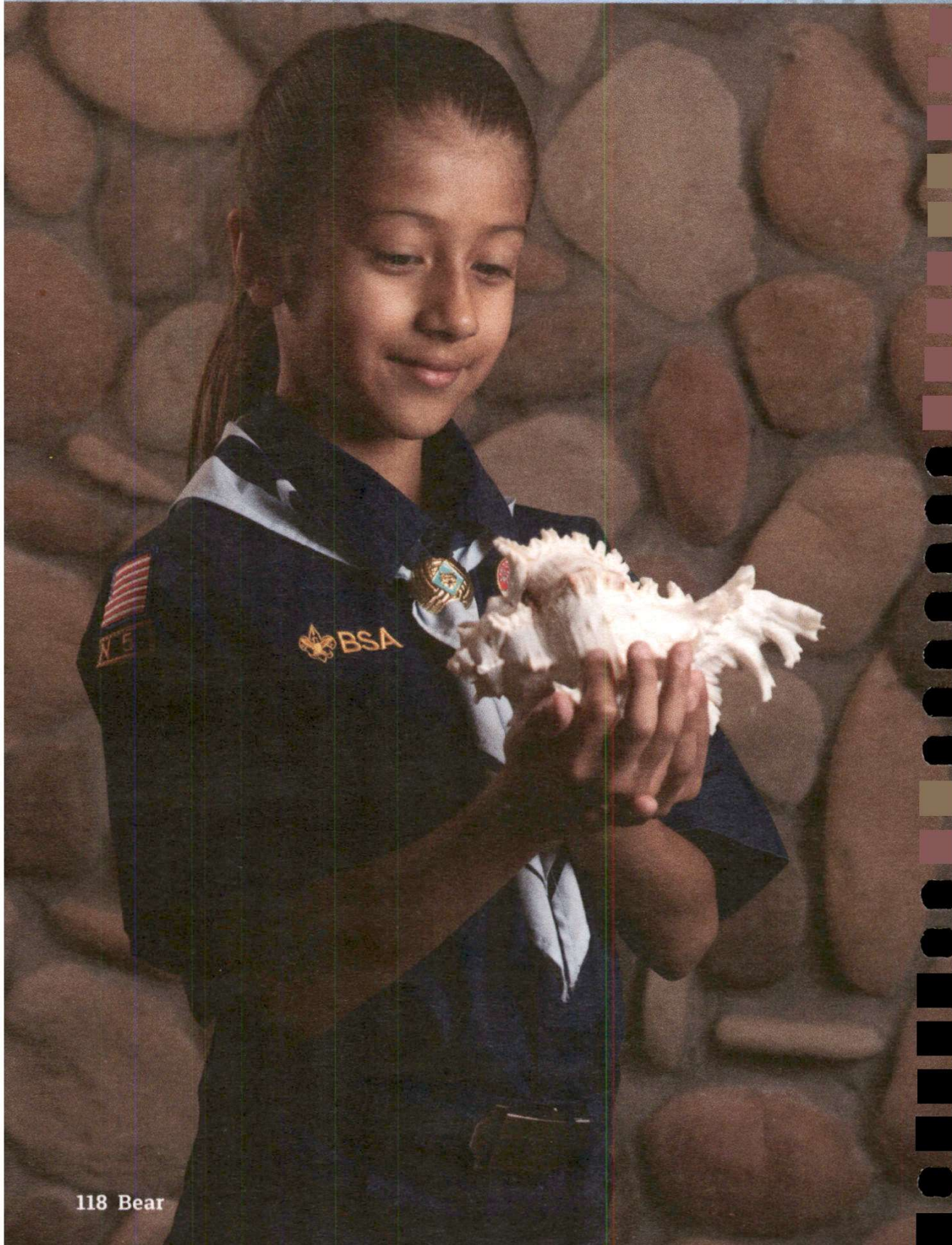



## SNAPSHOT OF ADVENTURE



You are probably familiar with a basic math problem like  $3 + 2 = 5$ . Mathematicians don't call these problems; they call them equations. The equal sign means that the expressions on the left side and right side of the equal sign are the same, or you could think of them as being balanced.

Math doesn't always involve adding and subtracting numbers. Finding patterns in things is the first step in becoming a mathematician. After spotting a pattern, a mathematician uses the math tools to find a way to recreate that pattern. In this Adventure, you'll have fun making "trail mix math." Then, you'll look to nature and discover a world of mathematics called symmetry in which things are balanced.

### REQUIREMENTS

1. Make trail mix using trail mix math.
2. Identify an animal that has a pattern to its physical appearance. Investigate how the animal uses its pattern.
3. Find examples of bilateral symmetry in nature.
4. Find examples of radial symmetry in nature.



- [Elective Adventure](#)
- [Scan for this Adventure page](#)



## REQUIREMENT 1

### Make trail mix using trail mix math.

The fun thing about trail mix is that you can make your own based on the foods you like. Some people like just three ingredients for their trail mix, some like six, and some may like more. Creating a good trail mix is about balance.

The original trail mix is called GORP, which stands for Good Old Raisins and Peanuts. This trail mix, created by hikers, is a favorite because the raisins and peanuts are easy to keep. The raisins give sugar for quick energy, and the peanuts give protein for longer-term energy and salt to help replace the salt your body loses when you sweat.

If trail mix only has sugary items, then it is only going to give you quick energy, and if your trail mix only has the protein, you will miss out on a needed boost for climbing a hill.

Time to make trail mix using trail mix math! Your trail mix will be divided into six parts or sixths. Each of the six parts must be equal. Together, your six parts will make a whole.

To make sure your trail mix is balanced, you're allowed one type of cereal, two items that are sweet, two items that are salty, and one type of nut. If you're allergic to any of these ingredients, you should make a substitution.



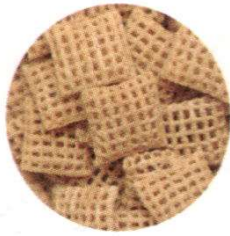

Cereal

$$\frac{1}{6}$$



Sweet

$$\frac{2}{6}$$

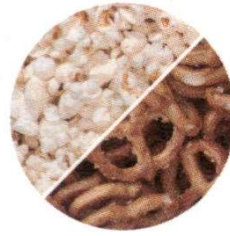

Salty

$$\frac{2}{6}$$



Nut

$$\frac{1}{6}$$

+

+

+

There are six parts to your trail mix and only one part is the cereal, which means that one-sixth of your trail mix is cereal. One part out of the six parts makes the fraction  $\frac{1}{6}$ . The top number is the numerator (one part cereal), and the bottom number is the denominator (how many parts make up the whole). All the parts or fractions must equal the whole.

Make your trail mix, and as you're eating it, can you write the fractions for each ingredient of your trail mix?

**My whole trail mix = 6/6**

Type of cereal (\_\_\_\_\_ ) = \_\_\_ / \_\_\_

Sweets (\_\_\_\_\_ ) = \_\_\_ / \_\_\_

Salty (\_\_\_\_\_ ) = \_\_\_ / \_\_\_

Nuts or other (\_\_\_\_\_ ) = \_\_\_ / \_\_\_



Date

Adult's Signature



## REQUIREMENT 2

Identify an animal that has a pattern to its physical appearance. Investigate how the animal uses its pattern.

A pattern is when a design is repeated. Animals may have patterns to protect themselves by hiding or confusing predators. Animals may also have patterns to help them hide as they are hunting. Using a pattern to hide is called camouflage. Here are some animals that have a pattern to their physical appearance.

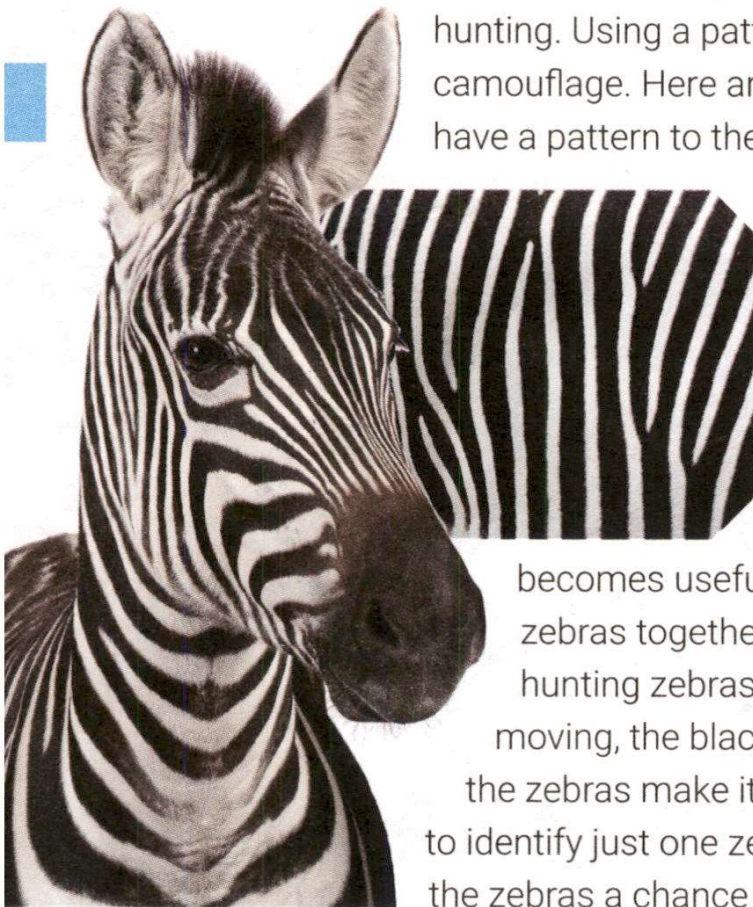

**Zebras** – The zebra has black and white stripes that repeat all over its body. These stripes are not very helpful to just one zebra. The pattern

becomes useful when there are several zebras together. When a predator is hunting zebras and the zebras start moving, the black and white stripes on all the zebras make it difficult for the predator to identify just one zebra. This confusion gives the zebras a chance to run away.

**Butterflies** – Butterflies use the patterns on their wings for different things. Some butterflies have a pattern that makes them look like they have eyes, confusing predators. Other butterflies have patterns that look like tree bark so they can hide from birds that may eat them.

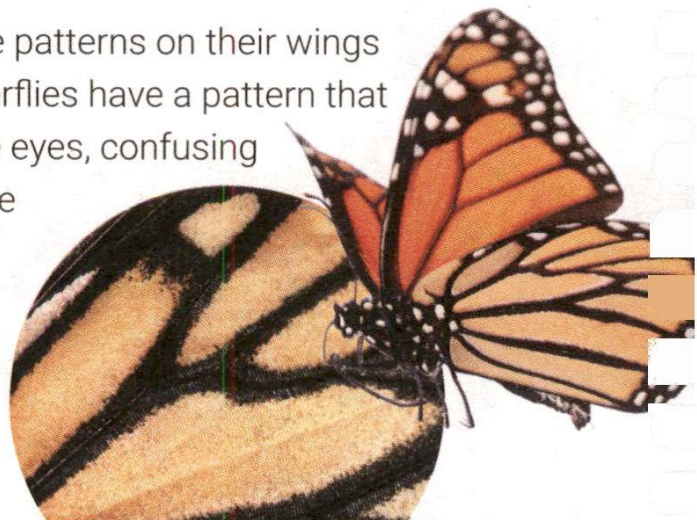





**Poisonous Dart Frogs** – The poisonous dart frog has very colorful patterns that are different from its surroundings. Instead of using patterns to hide, the poisonous dart frog uses its patterns as a warning. Eating the frog for most animals can make the animal sick or could even kill it. The color of the poisonous dart frog also tells how poisonous they are.

**Rattlesnakes** – Rattlesnakes have a distinct pattern on their skin that serves an important purpose. The alternating bands of color, typically brown or gray and black, help to camouflage the snake in its natural environment. This allows it to blend in with rocks, leaves, and other objects on the ground.

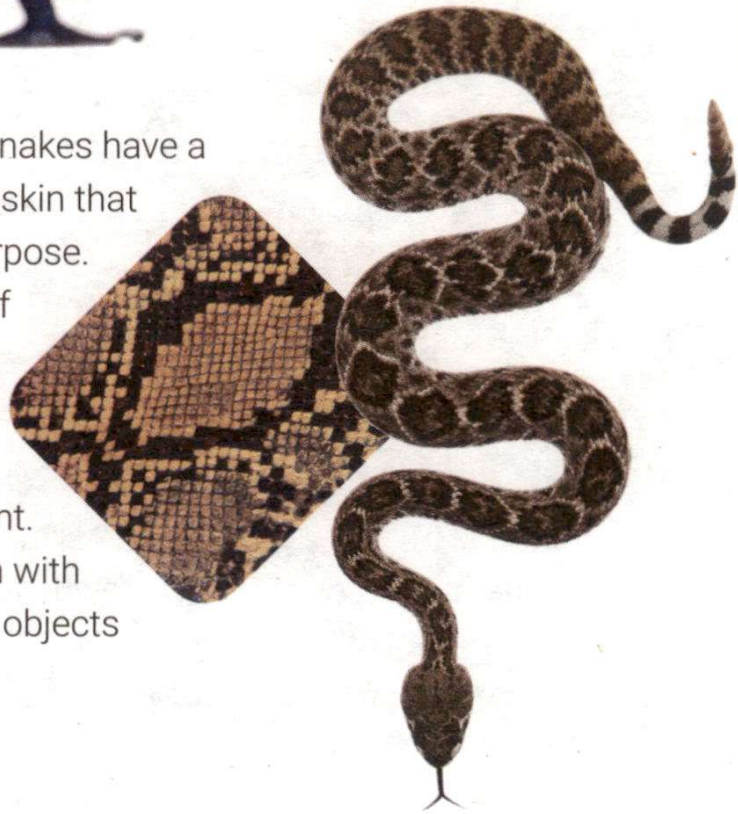

Date

Adult's Signature



## REQUIREMENT 3

Find examples of bilateral symmetry in nature.

Imagine you place a mirror halfway across something and then look at its reflection in the mirror. Does the object look the same in the mirror as it would without the mirror? That is bilateral symmetry. The word bilateral has the prefix "bi" in it, which means two. Bilateral symmetry means you can find two identical parts on either side of an invisible line down the middle.



A banana has bilateral symmetry. If you cut a banana in half long ways, from top to bottom, each half looks the same. However, if you cut the banana in half across the middle the top has a stem and the bottom half does not.

Sometimes it's easy to spot bilateral symmetry in nature; other times you may have to change the way you look at things. Take a look at some plants and animals to see if you can find bilateral symmetry.



Date

Adult's Signature



## REQUIREMENT 4

Find examples of radial symmetry in nature.

Radial symmetry is when something has an identical part that is repeated around a circle or radius. The first clue to finding something that has radial symmetry is that it will be round in shape.

An orange has radial symmetry. Like the banana, you have to cut the orange a certain way to see the symmetry. Cutting an orange in half, side to side, you'll see that the orange has sections that repeat themselves. Each orange piece has seeds, flesh, and skin. If you cut an orange from top to bottom you don't see the radial symmetry.

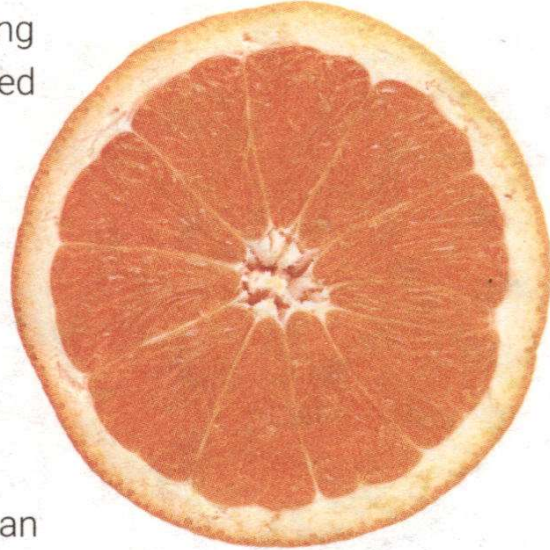

\_\_\_\_\_

Date

\_\_\_\_\_

Adult's Signature





# BALOO THE BUILDER

ELECTIVE ADVENTURE

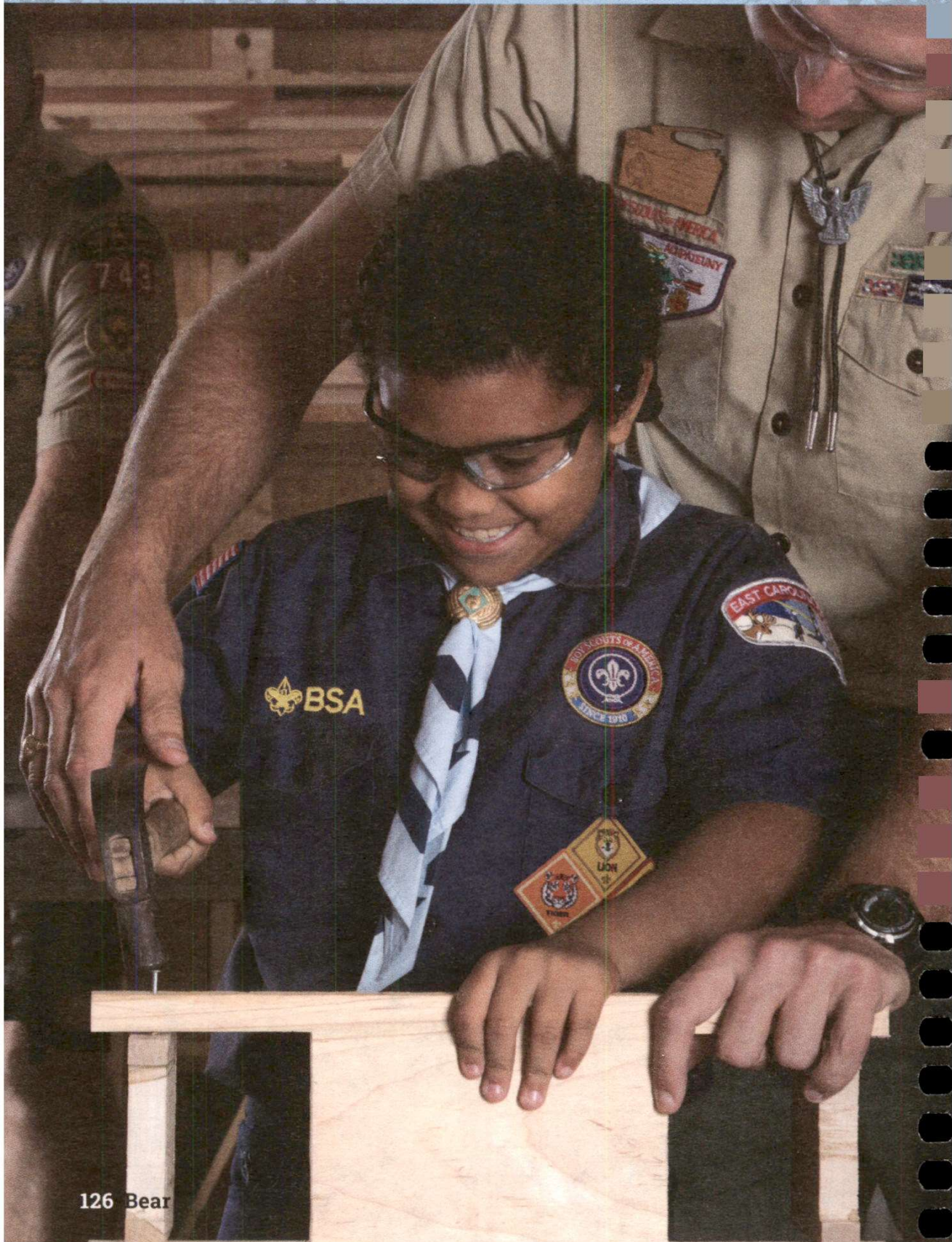



## SNAPSHOT OF ADVENTURE



Learning to build things that are useful or fun is an important skill. You might grow up to build houses as a career or models as a hobby. Or you might just learn some skills that will help you in everyday life.

Building materials may include wood, cement, plastic, steel, or a combination of all these things. For this Adventure, we will focus on wood. You will learn about hand tools and how to use them safely. You will learn how to choose the right type of wood for a project and follow project instructions. And before you're finished, you will use your new skills to make two projects from wood.

**If your project requires the use of a pocketknife, you must first earn the Whittling Adventure before using a pocketknife.**

### REQUIREMENTS

1. Learn about some basic tools and the proper use of each tool. Learn about and understand the need for safety when you work with tools.
2. Practice using four of the tools you learned about in requirement 1.
3. Choose a project to build.
4. Determine the tools and materials needed to build your project in requirement 3.
5. Build your project.



- [Elective Adventure](#)
- [Scan for this Adventure page](#)



## REQUIREMENT 1

Learn about some basic tools and the proper use of each tool. Learn about and understand the need for safety when you work with tools.



**Safety:** Cub Scouts are not allowed to use power tools. Safety is the primary concern as Bear Scouts learn to use woodworking tools.

A woodworker may have dozens — or even hundreds — of tools. You will need only a few tools to complete this Adventure. Using the right tool for the job is very important. This keeps your tools in good working order. It also keeps you safe. It is a good idea to inspect your tools before using them to be certain they are in good condition.

Here are some tools you might want in your toolbox. You may borrow these tools from your parent, neighbor, or den leader, but always ask permission first. When you have finished learning about these tools and how to use them safely, practice using them on pieces of scrap wood.

### SAFETY EQUIPMENT

Safety glasses aren't really tools, but they can help keep you safe when you're using tools. It is extremely important that you protect your eyes when working with tools and wood. You will need a good pair of safety glasses that are kid-sized.

Safety glasses are different from regular glasses or sunglasses. They are designed not to break when something hits them. They also cover a larger area around your eyes to keep sawdust and other construction debris out. Keep them clean with a soft cloth and store them in a safe spot.



## SMALL FIRST-AID KIT

When working with tools, it's always a good idea to have a small first-aid kit nearby. It should include adhesive bandages in case you cut yourself, tweezers, a small magnifying glass, and some first-aid cream, in case you get a splinter.



## HAMMER

A hammer is used to drive nails into wood. There are many different kinds of hammers. The best one for a Cub Scout is an 8- to 10-ounce claw hammer like the one shown here.

To drive a nail, hold it in place with one hand and tap it in gently with the hammer in your other hand. When the nail stands by itself, move your hand out of the way, and give the nail several firm hits with the hammer. For the most force, hold the handle near the end, not near the head.

If a nail bends, pull it out with the hammer's claws. Set a small block of wood next to the nail. Place the head of the hammer on the block of wood and slide the claws under the head of the nail. That creates a lever that helps you easily pull the nail out. Start over with a new nail.



**Safety:** Do not use a hammer that is too large or heavy for you. Grip the hammer tightly so it does not slip from your hand. Be careful of the fingers on your other hand. If they get in the way, it will hurt!



## SCREWDRIVER

A screwdriver puts a screw into a piece of wood. Screws do a better job than nails of holding projects together when the pieces will be under strain. There are two main kinds of screwdrivers: flathead and Phillips head. Pick the one with a tip that matches the screw you want to drive. A flathead screwdriver is used for a screw with a single slot across its head. A Phillips screw has a "+" design.

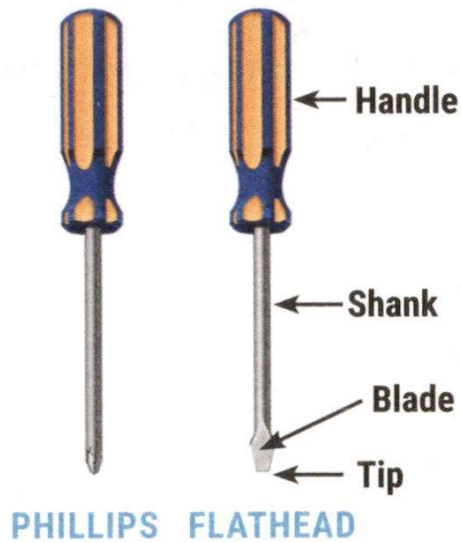

Screws go in more easily if you first make a pilot hole with a brace and bit (see the following page). The pilot hole should be smaller in diameter than the screw. It can also help to rub a little soap on the threads, or ridges, of the screw.



**Safety:** Use the longest screwdriver you can handle that is practical for your job. Pick the screwdriver that best fits the type of screw you are using. Only use a screwdriver to drive screws.





## BRACE AND BIT

A brace and bit is used to drill holes. This is a two-part tool. The bit does the drilling, and the brace turns the bit. There are many kinds and sizes of bits depending on the material and size of hole needed. All bits for wood have a spiral edge that digs out small pieces of wood as you turn it.

The brace has a hole where you insert the bit. Tighten the chuck so the bit is held firmly in place while you're working with it.

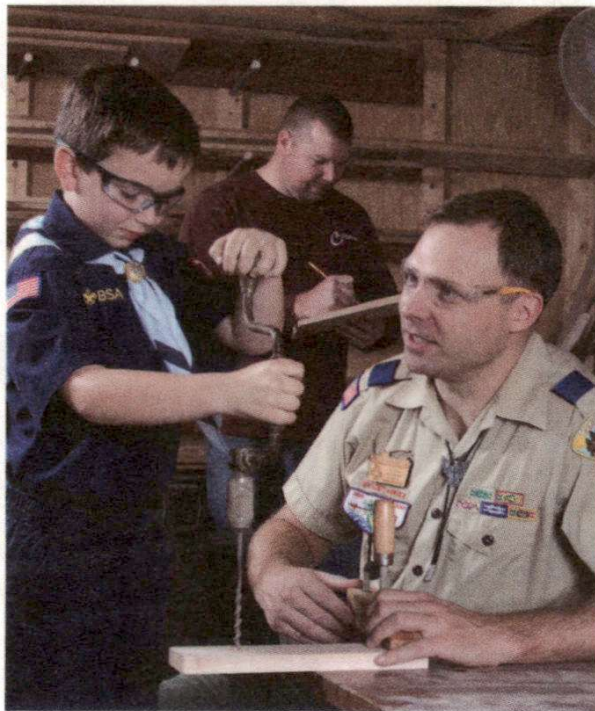
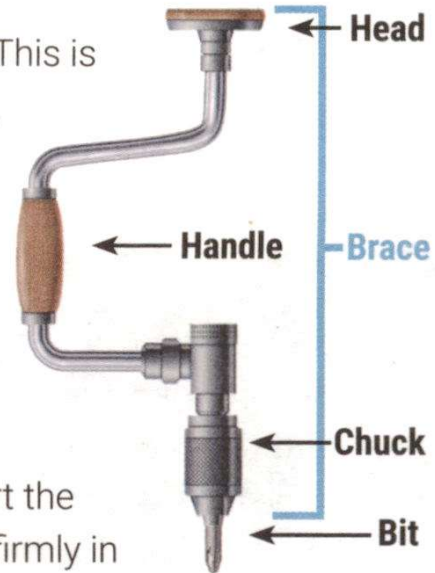

To use the tool, guide the bit into place with one hand. Press down firmly with one hand on the head to keep the bit in place. Turn the handle clockwise with your other hand to drill your hole. Before you drill all the way through the wood, turn the wood over, and finish your hole from the other side. This step will keep the wood from splintering.



**Safety:** The bit has a sharp point, so be careful when handling it. Use two hands. You may need an adult's help to get the hole started. Put on safety glasses before you begin.



## HAND SAW

A hand saw lets you cut boards along straight lines. A 20-inch hand saw is best for Scouts your age.

Before you begin sawing, draw a pencil mark on the board where you want to make your cut. Start the cut by making a notch on the mark at the edge of the board. This notch will act as a track for the blade to sit in. Steady the blade with your thumb well above the cutting edge, and then draw back gently to create the notch.

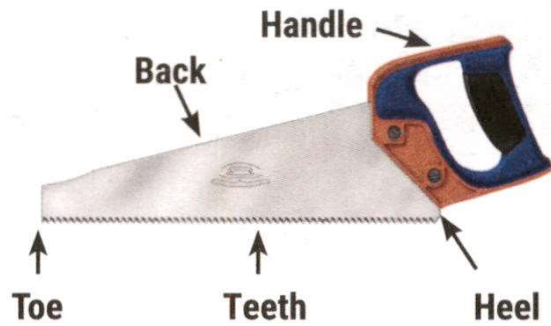

Now, remove your thumb, and begin sawing down the pencil mark. Be sure to tilt the saw at a 45-degree angle to the board.



Cutting the wood is a simple action of pushing the saw away from you at a downward angle, then pulling it back toward you. Each time you do this, the sharp teeth of the saw will cut deeper into the wood. You may need to straighten the saw handle to correct the direction of the cut, but be careful not to pinch the saw. If this happens, gently work the saw back and forth to release the blade.



**Safety:** A saw has sharp teeth. Be careful when you carry it and when you lay it down. It is a good idea to keep your saw hanging up when not in use so you don't brush up against the teeth. Always know where all your fingers are when using a saw. This tool will create sawdust, so safety glasses are a must.

## COPING SAW

A coping saw lets you cut curves and odd shapes in wood. Hold the wood securely with a vise or C-clamp (see below) so it can't move. Mark the curve you want to cut, then follow it with the saw, making long back-and-forth strokes. A heavy blade is a good idea.

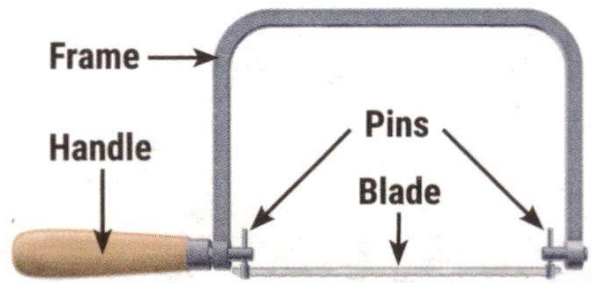

**Safety:** Like a hand saw, a coping saw has lots of sharp teeth. Be careful with your fingers, and wear safety glasses.

## WISE OR CLAMP

At times, you may feel like you need a third hand to hold the wood you're cutting or drilling. Using a vise or clamp is like having that third hand. To use a vise or clamp, place the wood between the jaws, then tighten the tension bar to hold the wood in place.

### WISE

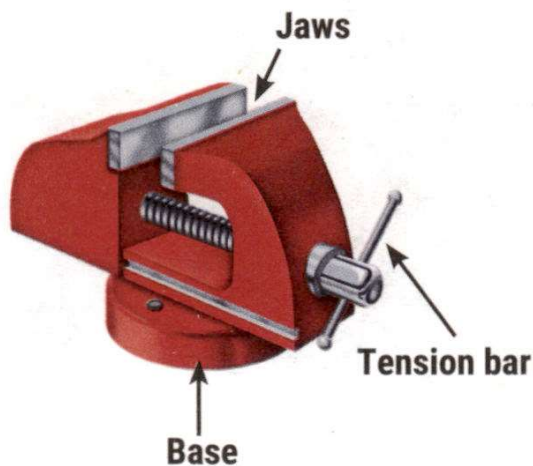

### CLAMP

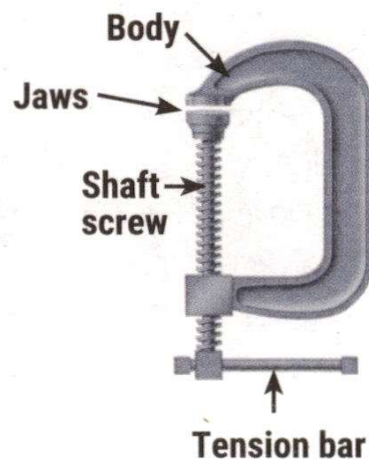

**Safety:** Vises and clamps can pinch fingers and hands, so be careful as you tighten them. If you're using a vise, make sure it's properly secured to a table.





## MEASURING DEVICE

Carpenters have a favorite saying: "Measure twice and cut once." To measure things you're cutting, you can use a measuring tape, a ruler, or a speed square. A speed square rests on the straight edge of a board to help you mark a straight line across it. A measuring tape or ruler lets you measure the length of a board you want to cut.

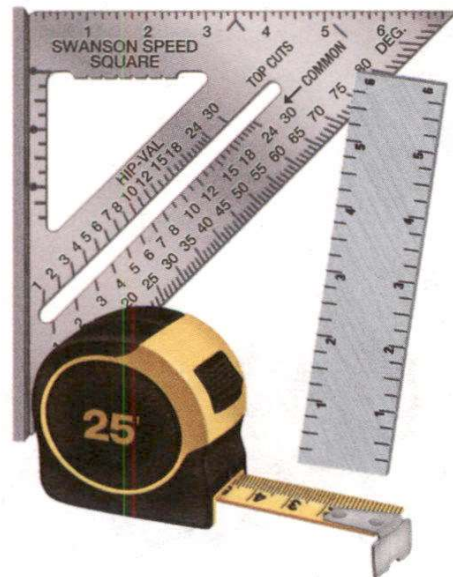







## REQUIREMENT 2

Practice using four of the tools you learned about in requirement 1.

### PRACTICING WITH TOOLS

**Here are some ways you can practice using your tools:**

- ▶ With a hammer, see how many hits it takes you to drive a nail into a piece of wood, or see how many nails you can drive in five minutes.
- ▶ With a screwdriver, see how long it takes you to place one screw through two small pieces of wood. You could also use a vise or a clamp with this, which is using two tools at one time.
- ▶ With a saw, see how well you cut using different thicknesses of wood. Check your cuts to make sure they are straight down, not slanted.

**I practiced using the following tools:**

1. \_\_\_\_\_
2. \_\_\_\_\_
3. \_\_\_\_\_
4. \_\_\_\_\_

Once you have finished with your tools, wipe them off with an old cloth or rag – being careful not to touch blades or sharp edges – and place them back where they belong. This will help your tools last longer. It will also help you find them the next time you need them.



\_\_\_\_\_

Date

\_\_\_\_\_

Adult's Signature

## REQUIREMENT 3

### Choose a project to build.

When choosing a project to build, you should first look at the instructions and consider the following:

- ▶ Who will be with you when building the project? An adult is to be with you the whole time.
- ▶ Do you have the right tools to make the project? If you don't, how will you get them?
- ▶ Do you have the materials needed to make the project? If you don't, how will you get them?
- ▶ How much time will it take to complete the project? Does it require time for glue or paint to dry?
- ▶ Where will you build your project?
- ▶ Is the location safe to use the tools you're using?
- ▶ If you can't finish your project right away, is there a safe place to keep it until you can finish it?

### **What type of wood will you use?**

If your instructions do not tell you the type of wood you need for your project, you can decide this by asking yourself some questions.

- ▶ Do I want to paint or stain my project? Some woods might hold paint better than stain. Also, you may want to paint an inexpensive wood that has some flaws. But you may choose to stain one that has lots of color or pattern.
- ▶ Does my project need sturdy wood to hold it up (like a stool, chair, or a table)?





- ▶ Is my project a showpiece (like a stand for a Pinewood Derby car) that will show off a pretty color or pattern of wood? Using wood with a pretty color or an interesting pattern is a fun way to make the project more attractive.
- ▶ Will my project ever be outside? If your project will stay outside (like a flower box), use a strong wood that takes paint well. Also use a good sealant so the weather won't damage it.

**Here are common types of wood you might use:**

- ▶ Pine, cedar, fir, cypress, and spruce are soft and easy to work with.
- ▶ Oak, walnut, hickory, maple, birch, and elm are hard and sturdier.
- ▶ Oak and walnut have interesting grains.
- ▶ Cedar has pretty colors and a nice smell.

If the type of wood you want to use is not important, think about finding wood that has been recycled. Your parent or den leader can help you locate a place to find recycled wood. Some ideas are reclaimed building supply stores, cabinet shops, or wooden pallet companies.



\_\_\_\_\_ Date

\_\_\_\_\_ Adult's Signature

## REQUIREMENT 4

Determine the tools and materials needed to build your project in requirement 3.

Once you have picked a project that is right for you, review the instructions and write down the tools, materials, and safety equipment you need. If you're going to paint or put a stain on your project, remember to include paintbrushes and cleaning supplies.

**Here is the safety equipment needed for my project:**

---

**Here are the tools needed for my project:**

---

---

---

**Here are the supplies needed for my project:**

---

---

---



Date

Adult's Signature



## REQUIREMENT 5

Build your project.

Here are some projects you may want to build with adult supervision.

### TIC-TAC-TOE BOARD

Cut a block of wood so it's 4 inches by 4 inches by 1 inch. Mark evenly spaced holes, and drill. Paint golf tees — five of one color for "X" and five of another color for "O." Saw golf tees to length to fit in holes.

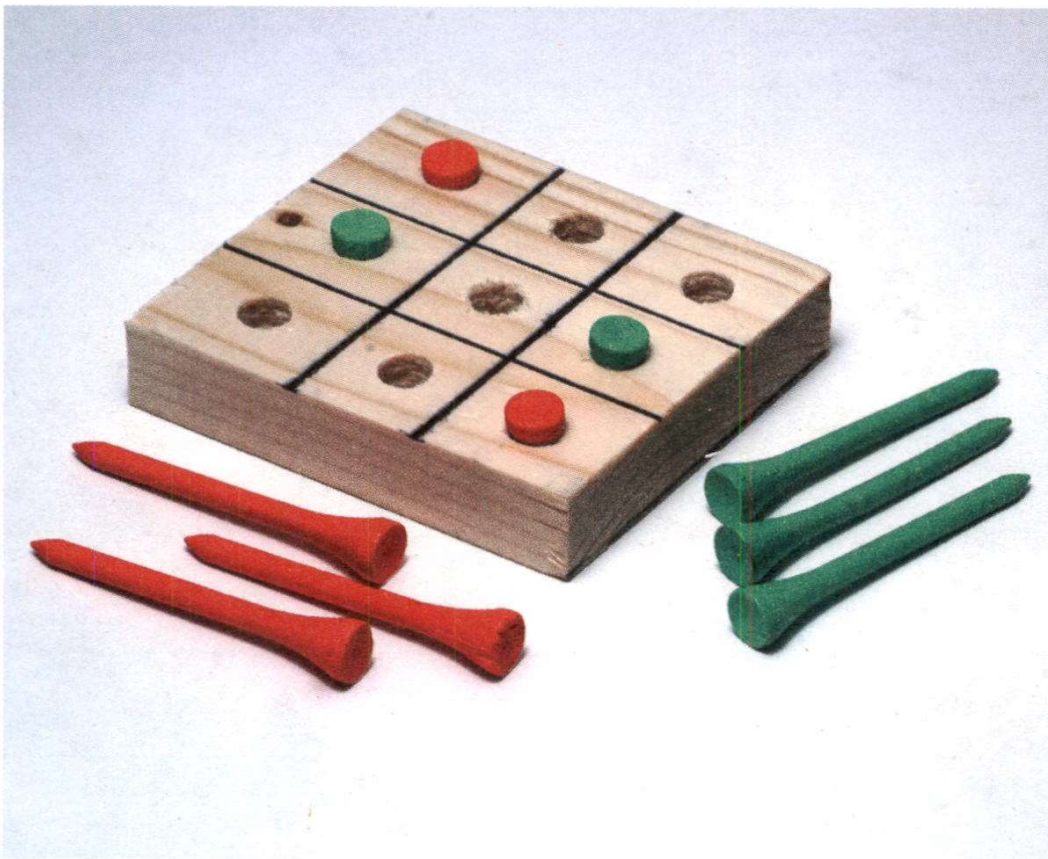

## TOOLBOX OR ART CADDY

### Materials and Tools

- ▶ Five 1-by-6-inch pieces of wood to be cut to various lengths
- ▶ Broomstick piece or dowel, 18 inches long, for the handle
- ▶ Wood screws
- ▶ Wood glue
- ▶ Hand saw
- ▶ Brace and bit
- ▶ Screwdriver
- ▶ Measuring tape

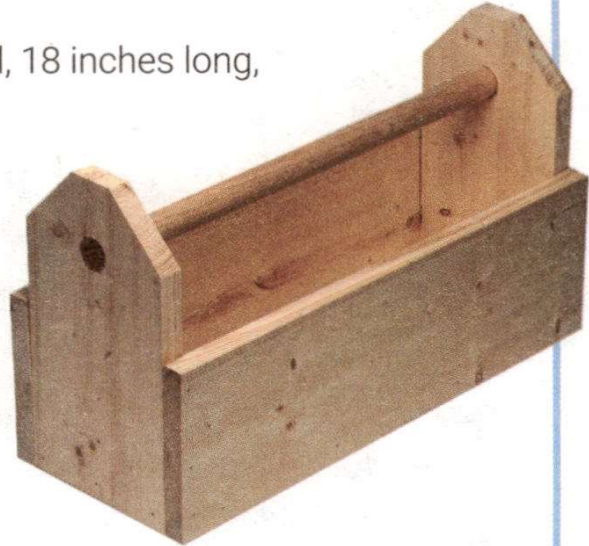



## Instructions

1. Cut two pieces of wood 17½ inches long for the two long sides.
2. Cut one piece of wood 16 inches long for the bottom.
3. Cut two pieces of wood 10 inches long for the ends.
4. Cut off the corners of the end pieces at an angle, then drill a hole in each large enough for the handle. The center of each hole should be 1¾ inch from the top and centered between the edges of the piece.
5. Insert the handle. Then, put your toolbox together with wood screws. If you wish, you may put wood glue on the joints and let it dry before using the wood screws.
6. Finish your toolbox using one of the methods described later in this chapter.

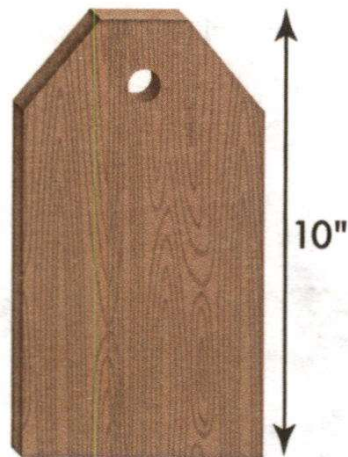
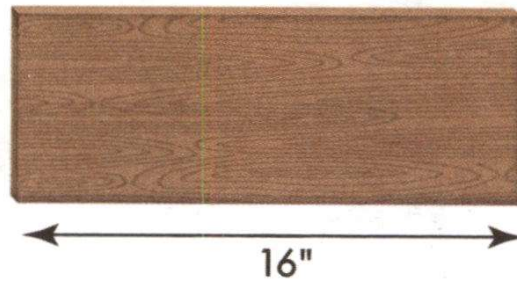
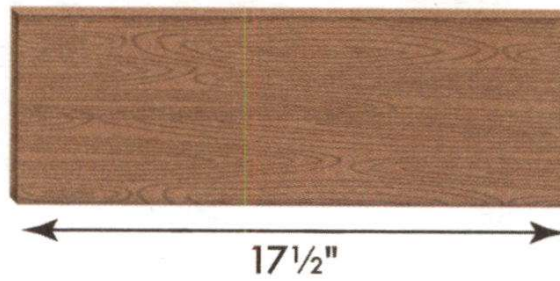

## CANDY DISPENSER

You can make this dispenser for jelly beans, gumballs, or any other hard candy that will fit in it.

### Materials and Tools

- ▶ One 2-by-6-inch board, 24 inches long (The actual size of a 2-by-6-inch board is 1½ by 5½ inches.)

### Cut the board as follows:

Two 1½-by-5½-by-5½-inch boards (top and base)

Two 1½-by-1¾-by-5½-inch boards (sides)

1-by-1⅞-by-11-inch board (slide)

- ▶ 1 dowel or peg about ¼ inch in diameter, 4 inches long
- ▶ 1 dowel or peg about ¼ inch in diameter, 2 inches long
- ▶ A clean quart or pint canning jar with its metal ring
- ▶ Crosscut saw for sawing across the grain
- ▶ Ripsaw for sawing with the grain
- ▶ 12 wood screws, 2½ inches long
- ▶ 4 flathead brads for nailing jar ring to top of dispenser
- ▶ Drill (**Only adults may use a power drill**)
- ▶ Drill bit, sized for pre-drilling 2½-inch holes
- ▶ Small drill bit for pre-drilling brad holes in jar ring
- ▶ Countersink bit (so driven screws are flush)
- ▶ ⅞-inch spade bit
- ▶ Screwdriver
- ▶ Tape measure
- ▶ Pencil
- ▶ Pocketknife
- ▶ Sandpaper
- ▶ Wood glue
- ▶ Jelly beans or gumballs

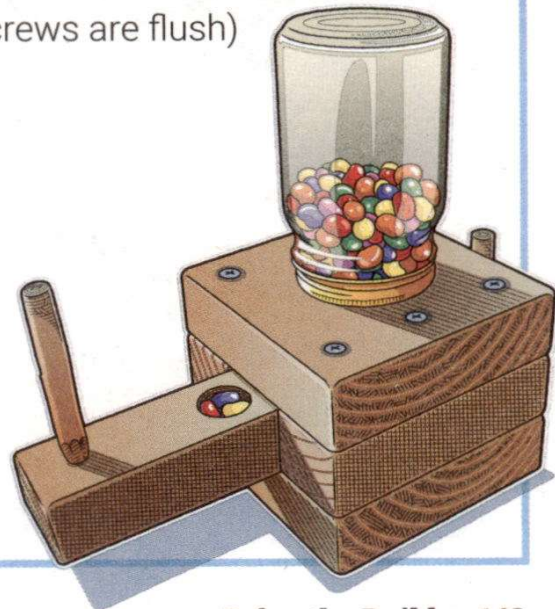



## Instructions

1. Cut all the boards to size and sand smooth.
2. Glue and screw the base onto the sides.
3. Pencil an X from corner to corner on the top board.
4. Have an adult drill a  $\frac{7}{8}$ -inch hole through the center of the top board.
5. Glue and screw the top board onto the sides and base. Sand the slide until it moves smoothly in the square hole in the center of the dispenser.
6. Have an adult drill a hole  $\frac{3}{4}$  inch from the front of the slide. This is for the 4-inch peg or dowel. Have an adult drill a hole  $\frac{1}{2}$  inch from the back of the slide. This is for the 2-inch peg or dowel. Glue the 4-inch peg or dowel in the front hole on the slide.

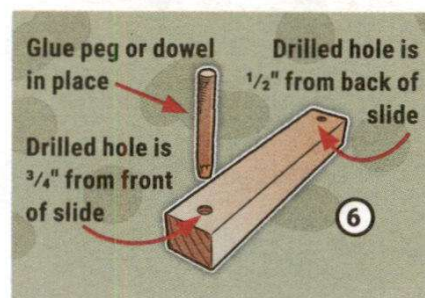
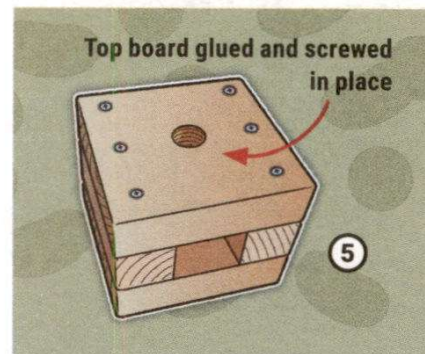
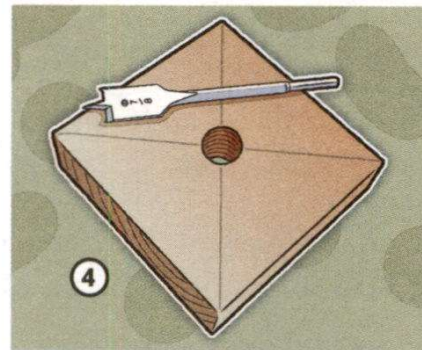
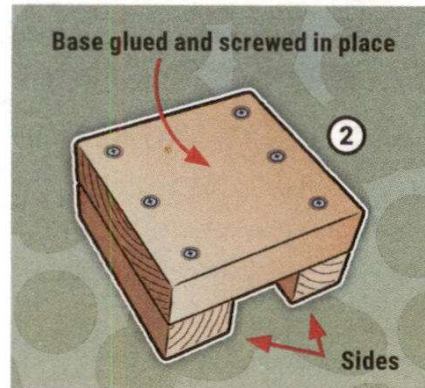
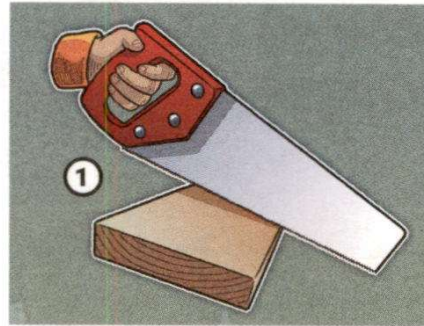

7. Push the slide into place until it stops at the 4-inch peg. Draw a circle through the  $\frac{7}{8}$ -inch hole on the top board onto the slide.

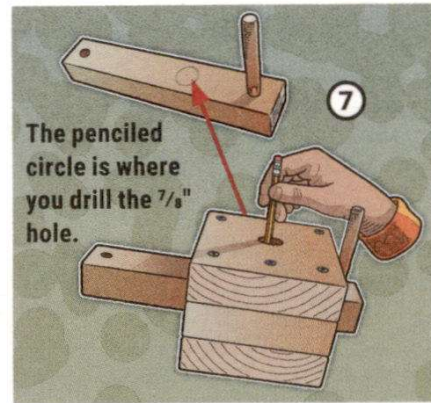

8. Have an adult drill a  $\frac{7}{8}$ -inch hole  $\frac{3}{8}$  inch deep into the slide as shown.

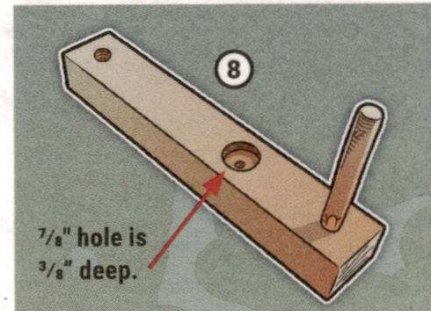

9. Bevel the  $\frac{7}{8}$ -inch slide hole with the pocketknife and sand smooth.

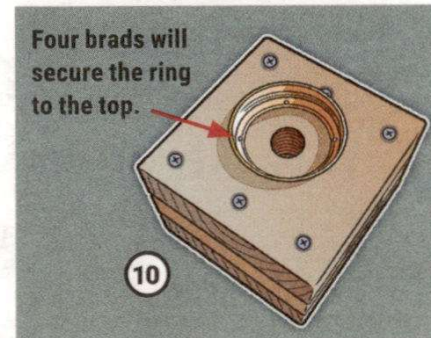

10. Have an adult drill and nail the jar ring onto the top board.

11. Push the slide into place. When the slide is pushed in all the way, the hole in the top and the hole in the slide should line up. Glue the 2-inch peg or dowel onto the back of the slide.

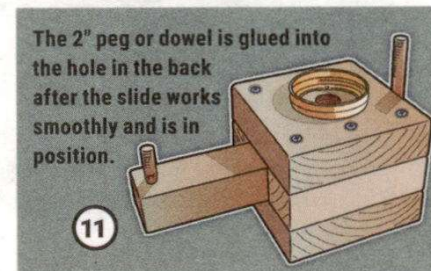

12. Fill the jar with candy, screw it onto the ring and your dispenser is complete.

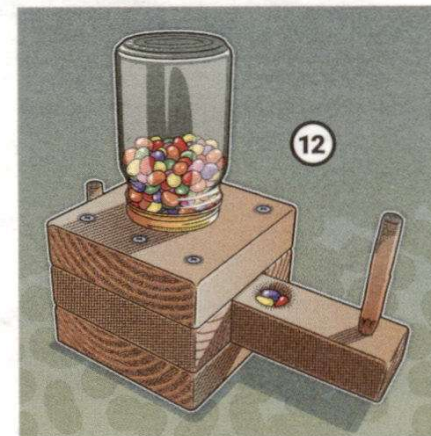



## BAT HOUSE

This simple one-chamber house will give those beneficial bug-eaters a much-needed roost. Here's how to build a simple bat house.

### Materials and Tools

- ▶ ½-by-30-by-36-inch sheet of exterior plywood (Don't use pressure-treated plywood; it's toxic to bats.)
- ▶ ½-by-26-by-36-inch sheet of exterior plywood
- ▶ 1-by-4-by-40-inch board for the roof
- ▶ Two 1-by-2-by-24½-inch boards for interior frame
- ▶ 1-by-2-by-36-inch board for interior frame
- ▶ Four 1-by-2-by-3-inch wood spacer blocks
- ▶ One quart of dark exterior water-based stain
- ▶ 53 1-inch exterior wood screws
- ▶ Seven 1⅝-inch exterior wood screws for the roof
- ▶ Crosscut saw
- ▶ Pocketknife (**To use a pocketknife you must first earn the Whittling Adventure.**)
- ▶ Paintbrushes
- ▶ Drill (**Only adults may use a power drill.**)
- ▶ ½-inch drill bit for vent holes
- ▶ ⅜-inch drill bit for screw pilot holes
- ▶ Countersink bit so screws are flush
- ▶ Phillips screwdriving bit
- ▶ Two squeeze tubes of exterior, paintable caulking
- ▶ One quart of exterior water-based primer
- ▶ Two quarts of exterior black or gray water-based paint

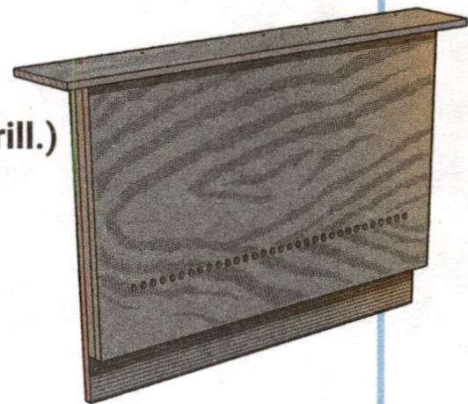

## Instructions

1. Cut out all the bat house boards.

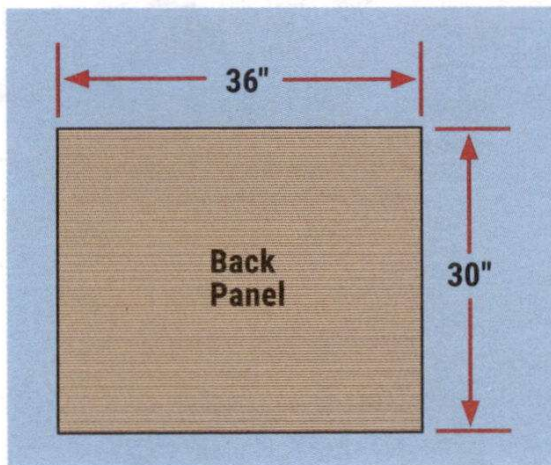
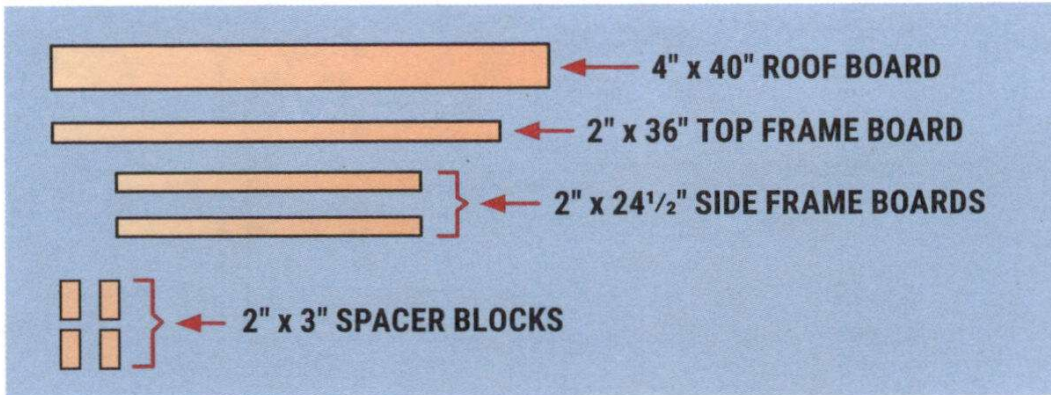

2. Use your pocketknife to scribe shallow grooves (less than 1/16 inch deep) across the inside of the back sheet of plywood, about ¼- to ½-inch apart. The grooves help bats grip the plywood.

3. Run a bead of caulk onto the contact surfaces of the interior frame and spacer blocks, and then screw them in place on the back of the front panel. All surfaces that are in contact with each other should be caulked before screwing them together. Caulking acts as a gasket, sealing out water.

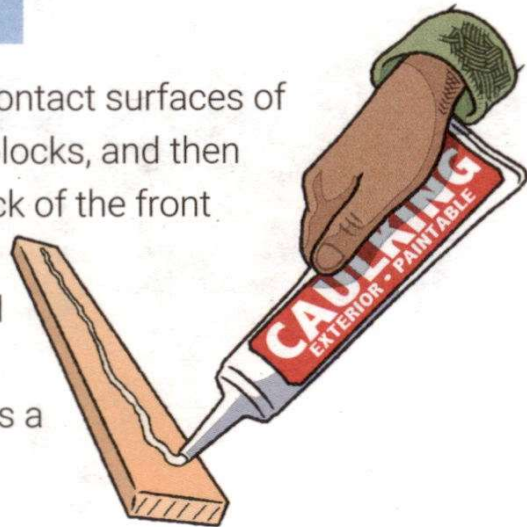



4. Have an adult drill  $\frac{1}{2}$ -inch vent holes in the front panel. In cold climates, you need only three or four vent holes.

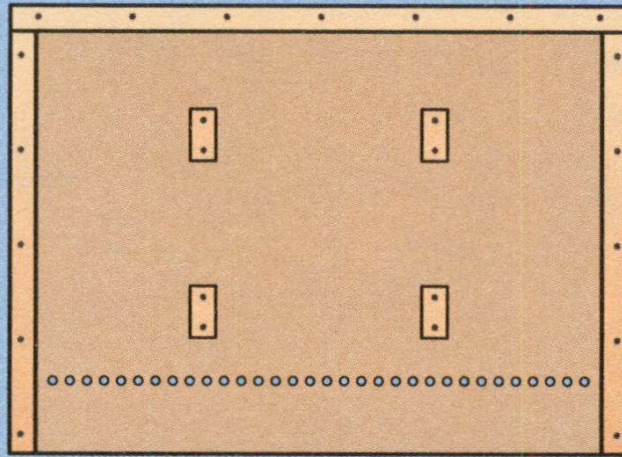

**Back view of front panel, showing vent holes.  
Frame and spacers are caulked and screwed in place.**

5. Stain the interior of the bat house, including the plywood, frame, and spacer blocks. Allow the stain to dry.
6. Caulk and screw the back panel to the frame and spacer blocks. Be sure to have an adult drill pilot holes to avoid splitting.

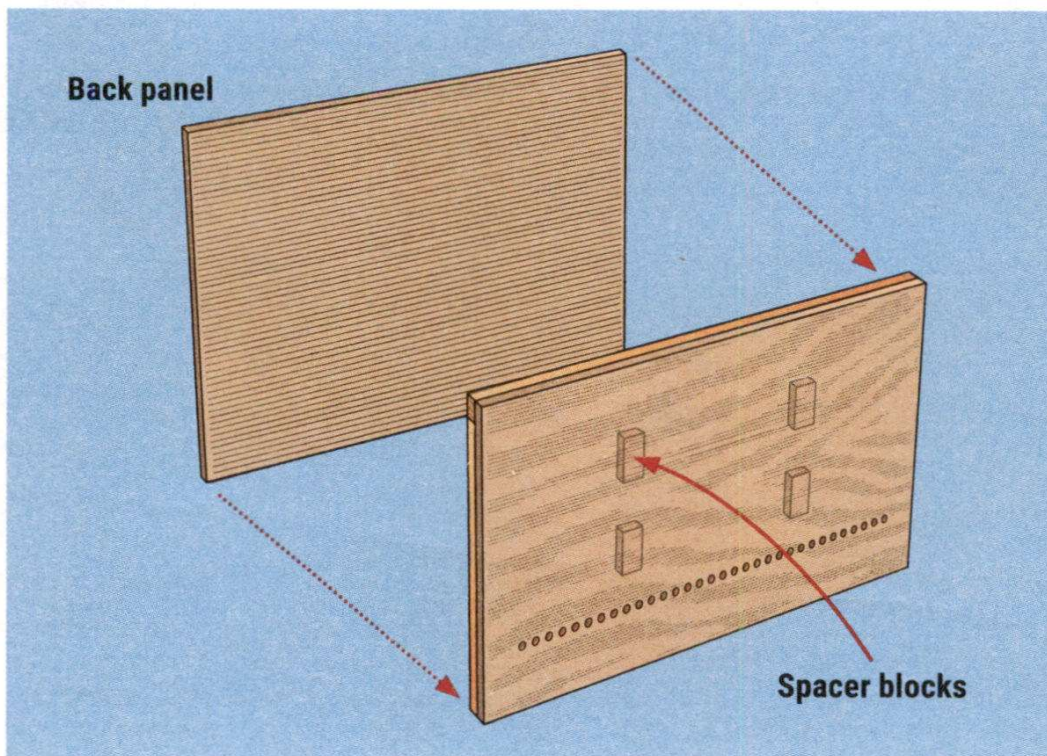



7. Caulk and screw on the roof. A drop of caulking in each screw pilot hole will help waterproof the bat house and keep the inside dry.

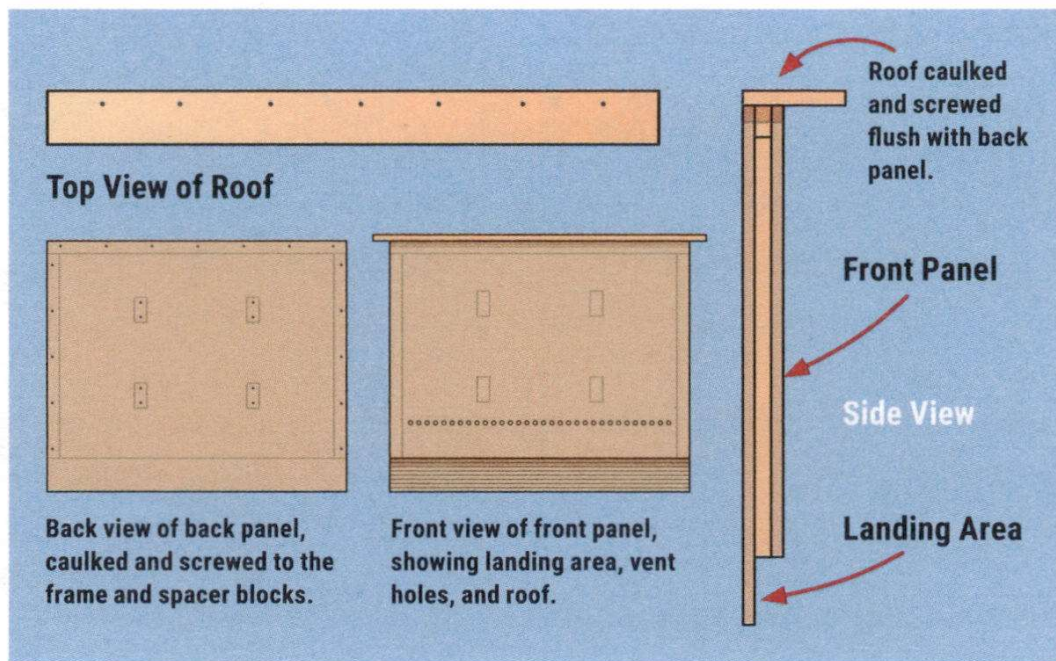

8. Paint the exterior with primer, then apply two coats of paint. Use black paint for colder climates and gray paint for warmer climates. Attach the bat house to a building or other structure. Face it south or east, about 10 to 12 feet off the ground.

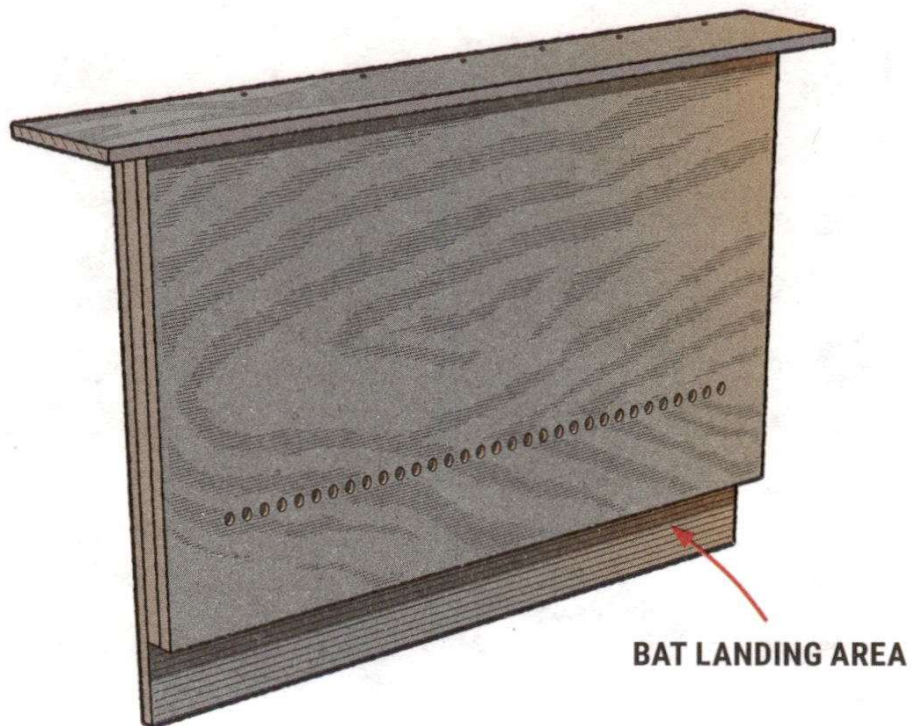



Once you have completed your project, you may want to put a finish on it. There are many ways to finish the wood. How you're going to use your project will help guide you in selecting the correct method of finishing it. Ask a parent or legal guardian to help with handling the finishes and cleaning fluids.

Always sand projects before you finish them. Sand the wood with the grain, never against it or in circles. To get the best results from sanding, use a wood filler for scratches and holes. When the filler dries, sand the project lightly again. You can use several finishes on wood projects: acrylics, varnish, enamel, and wood stains. Apply a clear wax polish to raw wood to emphasize the beauty of the natural wood grain.

### **Here are some things you should know about different finishes.**

- ▶ **Acrylics:** Acrylic paint is nontoxic and good for painting almost anything, including wood projects. It can be thinned with water and doesn't need a finishing coat. Clean your brushes with water.

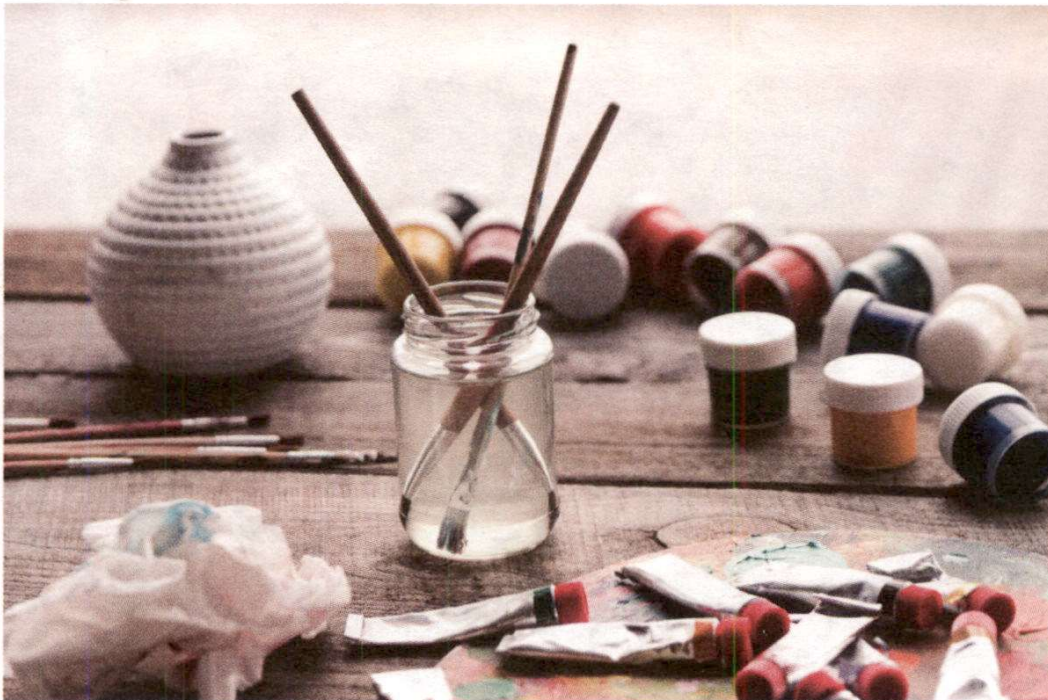



► **Varnish:** Prepare wood with one or two coats of thin shellac or wood sealer first, sanding between coats. This will fill the pores of the wood and prepare it for varnishing. Use shellac thinner or alcohol to clean the shellac brush, turpentine to clean the varnish brush.



► **Enamel paint:** Prepare wood in the same manner as for varnishing. Two thin coats of enamel produce a colorful finish. If it's too thick, it will leave brush strokes. Clean the brush with turpentine.

► **Wood stain:** To prepare the wood, moisten it with turpentine before applying the stain. Experiment on a scrap of wood to make sure the results please you. If it's too thick, it will leave brush strokes. Clean the brush with turpentine.



Remember to get help from your parent or den leader before you begin this part of your project. Always use finishes in a well-ventilated area and wear a paint mask and eye protection as well.



\_\_\_\_\_

Date

\_\_\_\_\_

Adult's Signature



# BEARS AFLOAT

ELECTIVE ADVENTURE

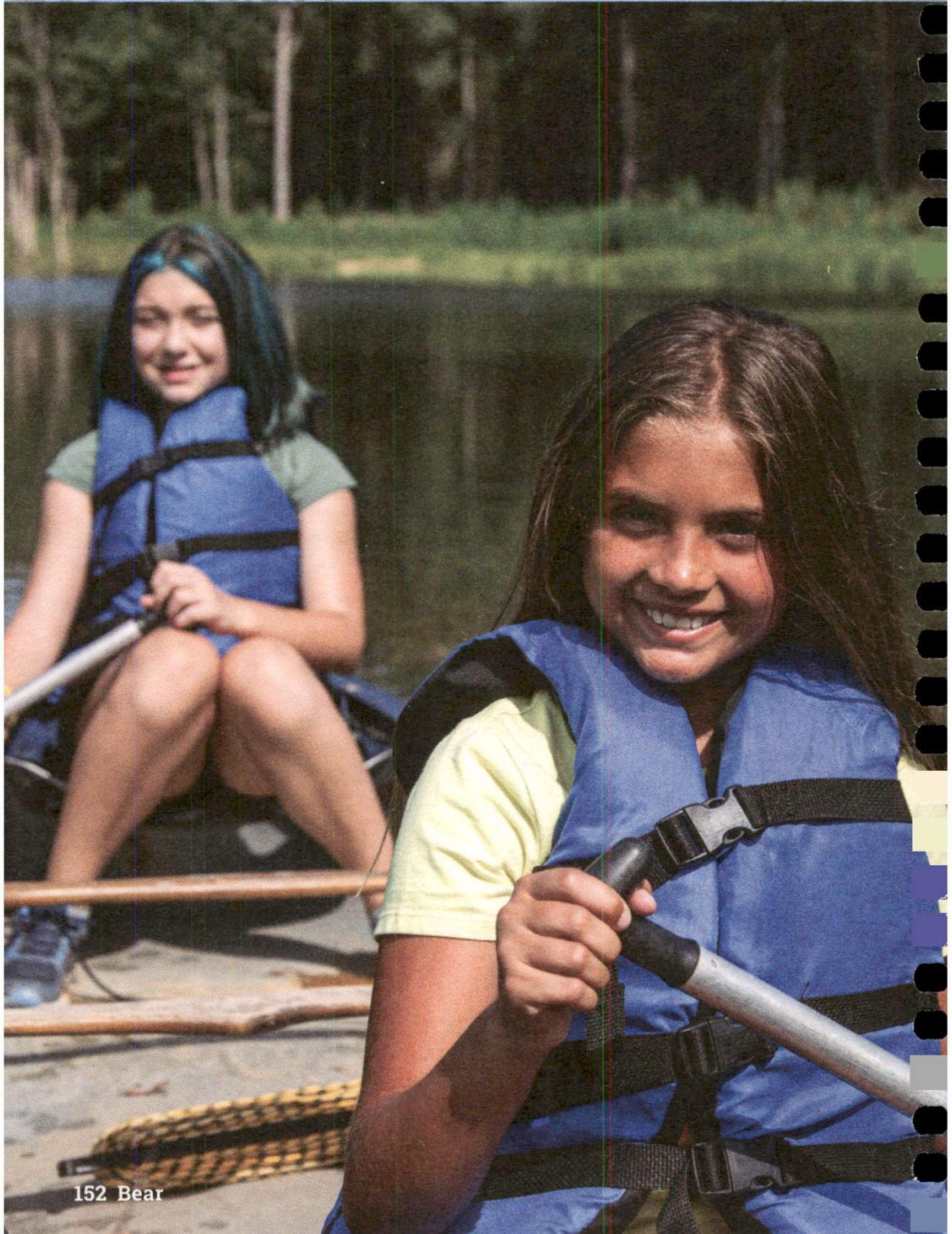



## SNAPSHOT OF ADVENTURE



Grip, shaft, throat, shoulder, blade, and tip are all parts of a paddle. In this Adventure, you'll discover the world of paddle crafts. Canoes, kayaks, and stand-up paddleboards all rely on you as the source of power. There are places that you can get to only by paddle craft.

You will also learn how to be safe when using a paddle craft, from learning about your equipment to proper ways to paddle your craft.

### REQUIREMENTS

1. Before attempting requirements 6 and 7 for this Adventure, you must pass the BSA swimmer test.
2. Pick a paddle craft you'll use to complete all requirements: canoe, kayak, or stand-up paddleboard.
3. With your den or an adult, discuss the role of qualified adult supervision at a paddle-craft activity.
4. Explain the safety rules to follow when safely using a paddle craft.
5. Discover how to tell if a life jacket is the correct size and approved for your paddle-craft activity. Demonstrate how to wear it.
6. Explore how your paddle craft responds as you move your paddle through the water from different places.
7. Have 30 minutes, or more, of canoe, kayak, or stand-up paddleboard paddle time.



- [Elective Adventure](#)
- [Scan for this Adventure page](#)



# REQUIREMENT 1

Before attempting requirements 6 and 7  
for this Adventure,  
you must pass the BSA swimmer test.



To learn more about the BSA swimmer test, follow this QR code.



\_\_\_\_\_ Date

\_\_\_\_\_ Adult's Signature

## REQUIREMENT 2

Pick a paddle craft you'll use to complete all requirements: canoe, kayak, or stand-up paddleboard.

### CANOE

A canoe is a narrow and usually lightweight boat that is pointed on both ends (the bow and stern) and is open. Canoes can be made of wood, fiberglass, or aluminum. The most common type of canoe is aluminum, since it's durable and easy to care for.

Like all boats, the front of a canoe is called the bow. It is identified by the distance the seat is positioned from the front of the boat allowing for leg room. The back of the canoe is called the stern. The seat is positioned closer to the back of the boat since your legs will be toward the middle of the canoe.

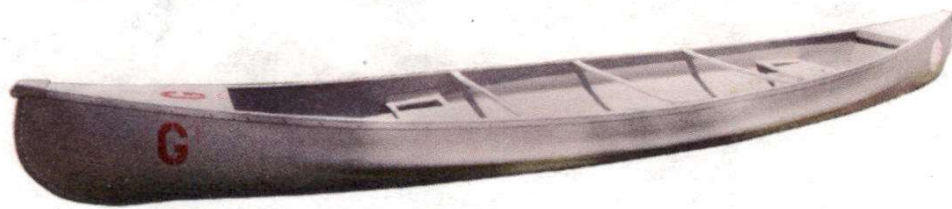

The sides of the canoe are called the gunwales (gun-l), the middle of the canoe is called the centerline, and the braces across the top of the canoe are called the thwarts.

Canoes are designed for flat water, like a lake or calm river.

### CANOE PADDLE

Canoe paddles come in different sizes. The proper size of a paddle is more about comfort and feel than an exact measurement. To see if a paddle is the right size for you, on land crouch down like you were sitting or kneeling in a canoe. Put the grip of the paddle on the ground with the tip pointing up. The throat of the paddle should be between your shoulder and nose.





## **KAYAK**

A kayak is a narrow and lightweight boat that is pointed on both ends. A kayak may be open, commonly called a "sit on top" or it may be closed with a cockpit. Kayaks can be made from wood, fiberglass, or plastic. The most common kayak is plastic, as it's durable and easy to care for, but they tend to be heavier.

Kayaks may be designed for a single paddler or for two paddlers (tandem). Kayaks come in many different shapes and sizes based on how they are to be used. Fishing kayaks tend to be open, are wide, and have attachments for fishing poles and equipment. Ocean kayaks are closed with a cockpit and may come with a "skirt" that the paddler wears to keep water out of the cockpit.



## **KAYAK PADDLE**

A kayak paddle has two blades. It is designed so there is constant power moving the kayak through the water. Kayak paddles are measured in centimeters. The most important thing about selecting a kayak paddle is the comfort of the paddle in your hands. To size your kayak paddle, hold the paddle above your head horizontally and centered. With your elbows bent at 90-degree angles, your hands should be 6 to 8 inches from the throat on either end of the paddle.



### **STAND-UP PADDLEBOARD**

A paddleboard is like a giant surfboard. It is commonly made of foam with a fiberglass coating. Some paddleboards are inflatable. You stand up on a paddleboard and while standing use a long paddle to move about the water. It requires balance and strength.



### **STAND-UP PADDLEBOARD PADDLE**

The paddle for a stand-up paddleboard is long and should be about 8 to 10 inches taller than you.



\_\_\_\_\_ Date

\_\_\_\_\_ Adult's Signature



## REQUIREMENT 3

With your den or an adult, discuss the role of qualified adult supervision at a paddle-craft activity.

Paddle crafts are all different types of boats. When boating during a Scouting activity, we follow the nine parts of Safety Afloat.

The first part of Safety Afloat is that for any boating activity in Cub Scouting, there must be an adult who has completed the Safety Afloat training and makes sure it's used during the activity. Below is the definition of qualified supervision for Safety Afloat. After reading it, discuss with your den or an adult what the responsibilities are of the adult who is serving as the qualified supervision.

It is best if the adult who will be the qualified supervisor for your paddle-craft Adventure leads the conversation and gives details on Safety Afloat.

1. **Qualified Supervision**—Supervision by an adult, 21 or older, who is trained in BSA Safety Afloat. Leadership is provided in ratios of one trained adult per 5 Cub Scouts. At least one leader must be trained in first aid that includes CPR. Any swimming done in conjunction with the activity must be within BSA Safe Swim Defense standards.



\_\_\_\_\_

Date

\_\_\_\_\_

Adult's Signature

## REQUIREMENT 4

Explain the safety rules to follow when safely using a paddle craft.

It is best if the adult who will be the qualified supervisor for your paddle-craft Adventure leads the conversation and gives details on Safety Afloat.

### BSA SAFETY AFLOAT:

2. **Personal Health Review**—Completing the BSA Annual Health and Medical Record will be needed. Are there any restrictions on the part of the participant?
3. **Swimming Ability**—Complete an annual swim test. Do you know what that is?
4. **Life Jackets**—Properly fitted U.S. Coast Guard–approved life jackets are worn by everyone engaged in boating activities.
5. **Buddy System**—Make sure each member is accounted for, especially when in the water.
6. **Skill Proficiency**—Everyone in an activity afloat must have sufficient knowledge and skill to participate safely.
7. **Planning**—Check for weather and contingencies as needed prior to your activity.
8. **Equipment**—All craft must be suitable for the activity, be seaworthy, and be capable of floating if capsized.
9. **Discipline**—Remember that rules are only effective when they are followed.



\_\_\_\_\_ Date

\_\_\_\_\_ Adult's Signature



## REQUIREMENT 5

Discover how to tell if a life jacket is the correct size and approved for your paddle-craft activity.  
Demonstrate how to wear it.

No matter what kind of boating you do, you must wear a properly fitted life jacket. The only life jacket you should use is one that has been approved by the United States Coast Guard.

Here is the performance list of Coast Guard-approved life jackets.

- ▶ Level 50 Buoyancy Aid: Not recommended for weak or nonswimmers. No self-turning ability.
- ▶ Level 70 Buoyancy Aid: Equivalent to the Type III life jackets. They are the most common life jackets worn by recreational boaters. No self-turning ability.
- ▶ Level 100 Life Jacket: High flotation life jacket. Some self-turning ability.
- ▶ Level 150 Life Jacket: High flotation life jacket. Offshore waters, self-turning ability.

You can see if the life jacket has been approved by the Coast Guard by locating the approval information printed on the inside of the life jacket. The approval information must be clearly legible. If not, the life jacket has reached the end of its useful life and may not be worn.

It is required that everyone, Cub Scouts and adults, wear a level 70 life jacket or above during paddle-craft activities.



**To make sure your life jacket fits, do this:**

- ▶ Check the label to see if it's designed for your size and weight.
- ▶ Put the jacket on, buckle it, and tighten the straps.
- ▶ Hold your arms over your head. Have a friend pull up on the tops of the arm openings. If the jacket rides up over your chin or face, it's too loose.



\_\_\_\_\_

Date

\_\_\_\_\_

Adult's Signature



## REQUIREMENT 6

Explore how your paddle craft responds as you move your paddle through the water from different places.

### PADDLE STROKES

With canoeing, both people in the canoe paddle, usually on opposite sides and stroking at the same time. The person in the back steers and gives directions, while the person in the front adds power and helps the canoe go straight.

To stroke a paddle properly, hold it firmly with both hands — one hand on the top of the handle and the other hand just above the throat, the area where the paddle starts to get wide. Bend forward a little, and let your upper body rotate as you paddle.

**Forward paddle strokes have three parts:**

**Catch.** Lower the paddle blade edgewise into the water in front of you, not too deep.

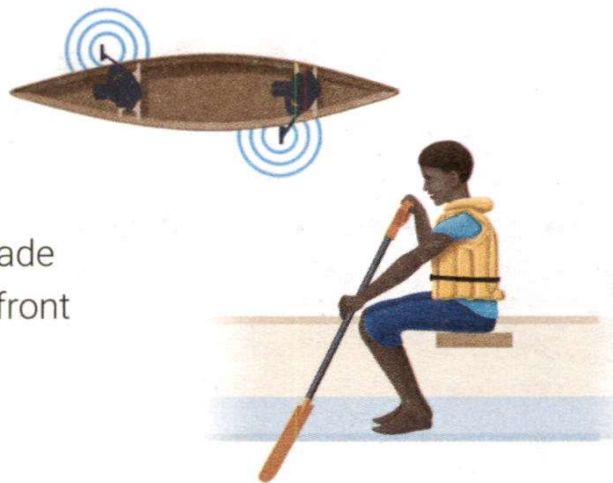

**Power.** Pull backward.



**Recover.** Position the paddle forward, ready to begin another stroke.



**Backstroke.** To do the backstroke, push on the paddle instead of pulling.

**Sweep.** Use sweeps to turn a canoe. Reach out with the paddle and move it in a quarter circle, either forward or backward. Or use draw and pry strokes, pulling or pushing the paddle straight toward or away from the canoe.



A kayak paddle has two blades that are curved, like a spoon. The curve of the blade is designed to catch the water. If your kayak paddles have an angled tip to them, the short part of the tip points down and the longer end of the tip points up. Grip the kayak paddle with your hands so they are the same distance from the center of the paddle.

To paddle, pick one side of the paddle to start with and place it forward in the water and pull back. Then you place the other side of the paddle in the water and pull back. Rotate your body as you paddle so your arms are not doing all the work.





A stand-up paddleboard paddle is long. You hold it like a canoe paddle with one hand on the top of the handle and the other hand on the shaft. The lower your hand is on the shaft of the paddle, the more power you will get from each stroke. Hold the paddle so that it's comfortable.

Now it's your chance to demonstrate these steps. You can practice before you get into a boat by standing in knee-high water and paddling like you would if you were in or on your paddle craft. Using a real paddle, show your den leader the correct form for paddling.



Reach forward by rotating your shoulders to plant the blade next to the board. This is called the catch.



Pull the board toward the paddle blade. This is the power phase.

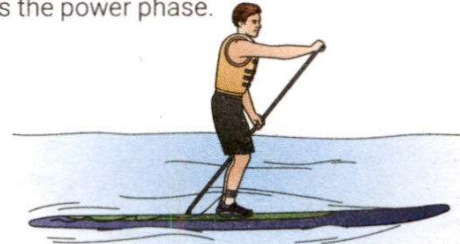

Before your lower hand reaches your hip, angle the blade out of the water to begin the recovery.

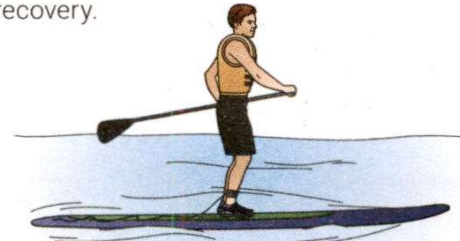

As you swing the blade back to the catch position, rotate your wrists to slice the blade through the air.

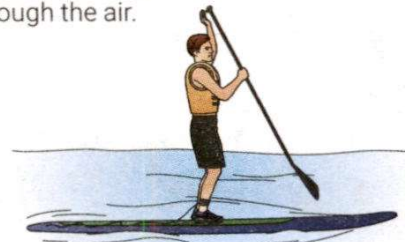

After a few strokes on the same side, switch sides to keep going straight.



Date

Adult's Signature

## REQUIREMENT 7

Have 30 minutes, or more, of canoe, kayak, or stand-up paddleboard time.

With the proper adult supervision and following Safety Afloat, enjoy your paddle craft. Your local Scout camp may have a perfect location and equipment you can use.



\_\_\_\_\_

Date

\_\_\_\_\_

Adult's Signature





# BEARS ON BIKES

ELECTIVE ADVENTURE





## SNAPSHOT OF ADVENTURE



Get together with your den, pack, or family to go on a bike ride. In this Adventure, you'll learn what to wear to ride your bike safely and some basic maintenance. Then get ready for a bike ride. Grab your helmet, check your tires, and take a buddy to head out on another Cub Scout Adventure.

### REQUIREMENTS

1. Show how to properly wear a bicycle helmet.
2. Decide what you should wear when riding a bike.
3. Demonstrate proper hand signals.
4. Demonstrate how to adjust saddle height.
5. Demonstrate how to operate brakes.
6. Learn how to use a pump to inflate your tires. Discuss why riding with low-pressure or flat tires is unsafe and can cause damage to your bike.
7. With your den, pack, or family, follow the buddy system, and go on a 30-minute bike ride.



- [Elective Adventure](#)
- [Scan for this Adventure page](#)



## REQUIREMENT 1

Show how to properly wear a bicycle helmet.

Work with your den or caring adult to try on bicycle safety gear. If you have your own helmet or other gear, you may want to bring it with you to your den meeting.

### HELMET

A hard-shell helmet with a chin strap is your most important piece of bicycle safety gear! Always wear a hard-shell helmet with a chin strap when you go biking. Make sure it fits so it can help protect your head if you fall off your bike. In Cub Scouting, everyone is required to wear a helmet when riding a bicycle.



- ▶ Your helmet should sit snugly on your head but not so tightly that it's uncomfortable.
- ▶ The front of the helmet should sit two fingers above your eyebrows. If the helmet is tipped back, it won't protect your forehead.
- ▶ The side straps should make a "V" around your ears.
- ▶ Use the "one-finger rule" to fit your chin strap. The buckle should be centered under your chin. Tighten it so you can fit only one finger between it and your chin.





If your helmet slips and slides, then take it off and adjust the fit. With your caring adult's help, learn how to adjust the helmet following the manufacturer's instructions, so it fits correctly. Practice fastening and unfastening your chin strap by yourself. Always make sure it's fastened before you ride!



\_\_\_\_\_

Date

\_\_\_\_\_

Adult's Signature



## REQUIREMENT 2

Decide what you should wear when riding a bike.

When you go on a bike ride, you should consider the weather when determining what you should wear. Will it be hot and sunny? Is there a chance of rain?

**In addition to what the weather will be like, keep this in mind:**

- ▶ Always wear closed-toe shoes with socks.
- ▶ Wear clothing that stays close to your body.
- ▶ If wearing long pants, make sure they won't get caught in your pedals or bike chain.
- ▶ Bright colors that make you visible are best.

Kneepads and elbow pads can save your skin from scrapes! If you fall off your bike on gravel, dirt, or pavement, you'll be glad you were wearing them.

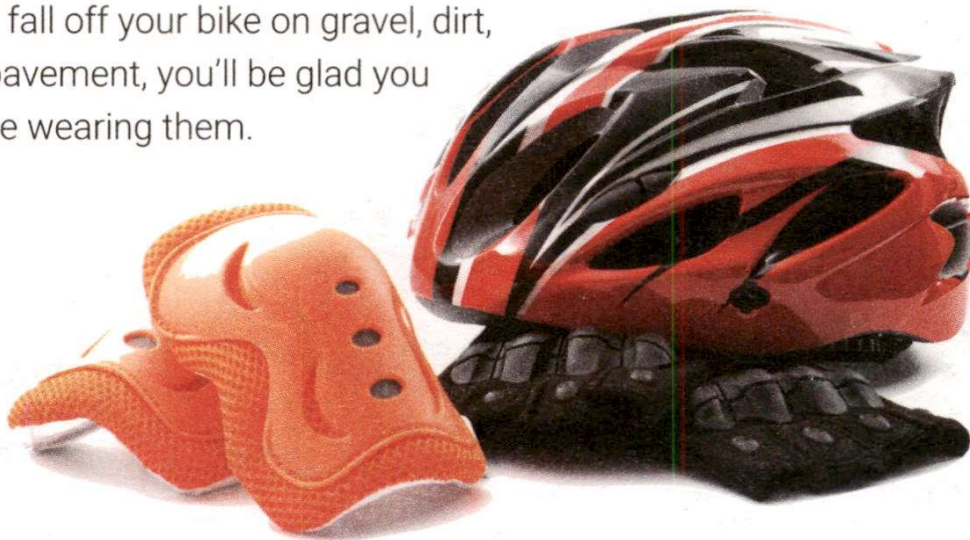



Reflective tape and light-colored clothing make it easier for people in cars to see you. Wear reflective tape on the front and back of your jacket, helmet, wheel spokes, and even your pant legs. A flashing light on your jacket, the back of your bicycle seat, or backpack also helps motorists see you even during the day.



Each state has laws about safety gear and helmets. With your den or caring adult, check with your local or state police to find out the laws before you ride.



Date

Adult's Signature



# REQUIREMENT 3

Demonstrate proper hand signals.

It is important to always use hand signals when you're riding your bicycle. Learn the proper signals for turning right or left or stopping. Make sure you signal in plenty of time before you turn so people in cars know what you're going to do. Show your caring adult or your den leader how to use hand signals for turning left, turning right, and stopping.



Left Turn



Stopping



Right Turn



Alternate Right Turn



\_\_\_\_\_ Date

\_\_\_\_\_ Adult's Signature

## REQUIREMENT 4

### Demonstrate how to adjust saddle height.



A bike can last a long time. Since you're still growing, you may need to adjust the saddle (seat) height of your bike. When sitting on the saddle of your bike, you should be able to touch the ground with only your tiptoes; you shouldn't be able to put your feet flat on the ground. If you can put your feet flat on the ground when sitting on the saddle, you need to raise your saddle height.

You should always refer to the owner's manual for your bike. If you don't have the owner's manual, chances are, you can find it online with help from an adult.

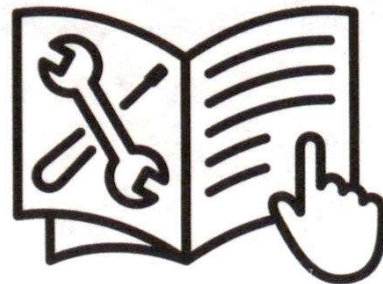



Most bikes have a pinch-bolt system to adjust the saddle. Look for it just below the saddle on the frame of the bike. A pinch bolt looks like a lever. You pull the lever back and it will loosen the seat post, allowing you to move the saddle up and down. Once you have the saddle at the right height, push the lever back in place.

If you find that your saddle is sliding down when you ride it, you'll need to tighten the pinch bolt. To tighten a pinch bolt, pull the lever back to loosen it and turn the lever to the right (clockwise). You may only need to turn it once, then push the lever back into place.

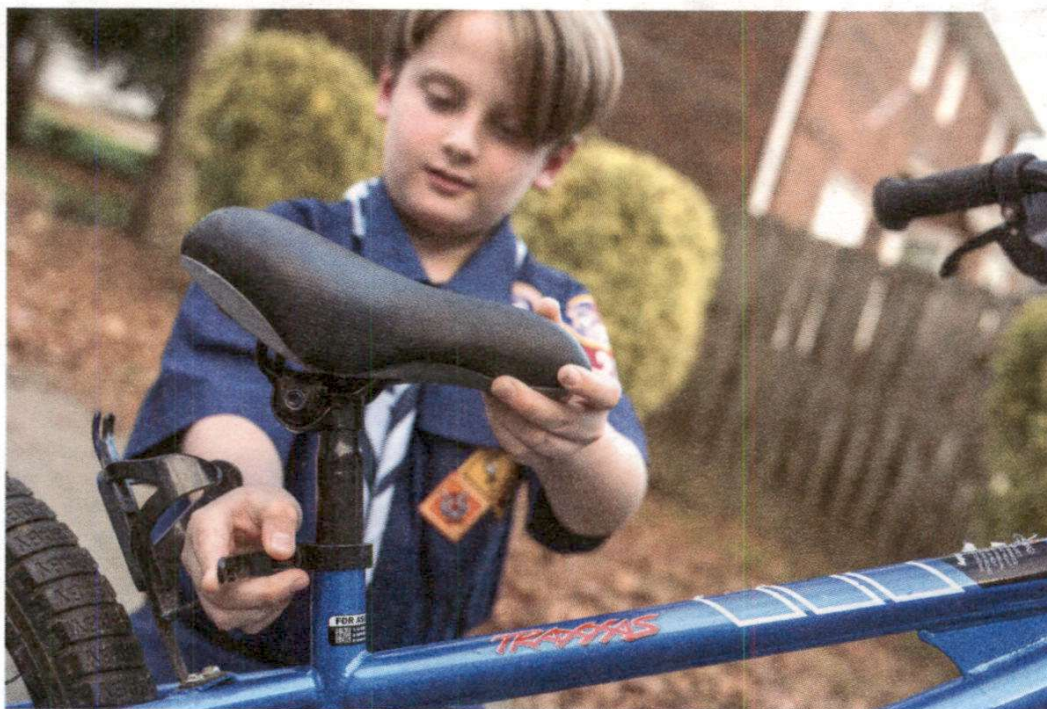

\_\_\_\_\_

Date

\_\_\_\_\_

Adult's Signature

## REQUIREMENT 5

Demonstrate how to operate brakes.

Determine if your bicycle uses handbrakes or coaster brakes. Your bike may have one or two handbrakes. You will see these

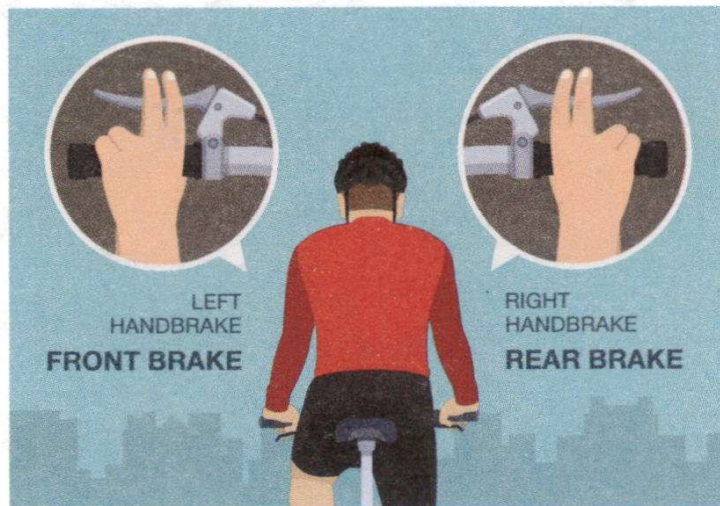

as levers on the handlebars on your bicycle. If you have one handbrake, it should be attached to the back wheel. When you use the brake, the back wheel

comes to a stop. If you have two handbrakes, usually the rear brake is on the right and the front brake is on the left.

When using handbrakes, you want to use the rear brake to stop. To come to a quick stop, first use the rear brake and while holding down the rear brake, start using the front brake. Never use the front brakes only.

If your bike doesn't have handbrakes, then it's probably a coaster bike. To brake the bike, pedal backward.

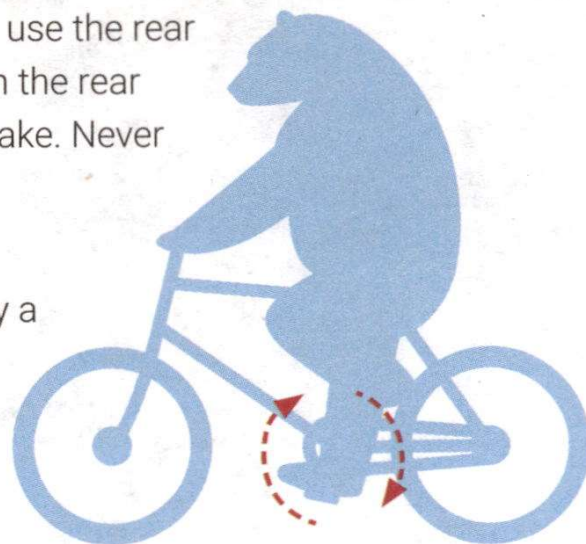

Date

Adult's Signature



## REQUIREMENT 6

Learn how to use a pump to inflate your tires. Discuss why riding with low-pressure or flat tires is unsafe and can cause damage to your bike.

There are several different types of bike pumps. Some are manual, which means you use your arms or foot to add air to the tires. Electrical pumps compress air for you. If you have an electrical pump that uses compressed air, you should ask an adult to help you.

Most bicycle pumps will have a gauge (dial) that shows how much air is in the tire. This is measured in pounds per square inch or PSI. A reading of 25 PSI means that for a square that is one inch by one inch, 25 pounds of pressure are pushing on it.

Every time you go for a bike ride, check your tire pressure. The pressure in your tires can change based





on how hot or cold it is outside. If you find that your tires are flat every time you want to go on a bike ride, you may have a leaky tire. You may need to patch the tire or get a new one.

Your bike tire will tell you how much air it should have in it. Look for a spot on the tire that gives the PSI. The type of bike you ride and the tire you have will determine how much PSI is needed.



When adding air to the tire, constantly check the PSI gauge and stop inflating the tire when the correct amount of air is in the tire.

Tires that have low air in them don't work as well. They will cause more friction when you pedal, making it harder to pedal. The tire may not grip the ground properly causing it to slide, which may lead to you falling down. Never ride on a flat tire. It may cause you to fall down, but it will also damage the wheel of the bike. It may cause it to lose its shape or damage it so that even a new tire will not fit properly.



\_\_\_\_\_

Date

\_\_\_\_\_

Adult's Signature



## REQUIREMENT 7

With your den, pack, or family, follow the buddy system, and go on a 30-minute bike ride.

See new places on a bike ride with your den, pack, or family. On a bike, you can feel the wind on your face. You can move fast. You will see, hear, and smell things around you that you might miss riding in a car. Remember to grab your Cub Scout Six Essentials, complete a bike safety check, wear your helmet and safety gear, and grab a buddy.

Bike rides are most enjoyable when taken on paths or trails designed for bikes, away from vehicle traffic, and free of hazards. During your 30-minute bike ride, take a break and drink some water when you feel the need.



Make sure you understand the bike rules as well as the traffic rules where you live. Biking is a big responsibility. Stay alert, and ride in a single file. Leave enough space between you and other bikers. That way, if others stop suddenly, you won't run into them. A bike ride is your chance to get outdoors to practice the bike tips you learned — and have a great time doing it. Stay safe and enjoy the ride.





Date

Adult's Signature



# CHAMPIONS FOR NATURE

ELECTIVE ADVENTURE





## SNAPSHOT OF ADVENTURE



We have three important resources for all living things on our planet: water, soil, and air. We use water to clean ourselves, our dishes, and our clothes. Soil is the resource that allows us to grow food. The air we breathe goes into our lungs, providing our bloodstream with oxygen. In this Adventure, you'll discover more about the resources of water, soil, and air and put what you discover into use with a conservation project. Knowing more about the resources of the planet will help you make good decisions about conserving the resources of our world.

### REQUIREMENTS

1. Discover natural resources.
2. Discover what happens to the wastewater in your community.
3. Investigate soil.
4. Investigate air pollution.
5. Participate in a conservation project.



- [Elective Adventure](#)
- [Scan for this Adventure page](#)



# REQUIREMENT 1

Discover natural resources.

Natural resources are resources that come from nature and are used with few modifications. Natural resources include minerals, wood, and water. When you go camping and you have a campfire, the wood you burn



is a natural resource. Some natural resources can be used only once, like burning wood. Other natural resources can be reused, like wood used for buildings.

You can discover natural resources by taking a walk in your community. Look for things in nature that could be used responsibly by people or products that come from nature, like certain building materials.



Date

Adult's Signature

## REQUIREMENT 2

Discover what happens to the wastewater in your community.

Wastewater is used water. It can come from one source or a combination of sources. Wastewater can come from domestic, industrial, commercial, or agricultural activities; surface runoff; and the sewer system in your town.

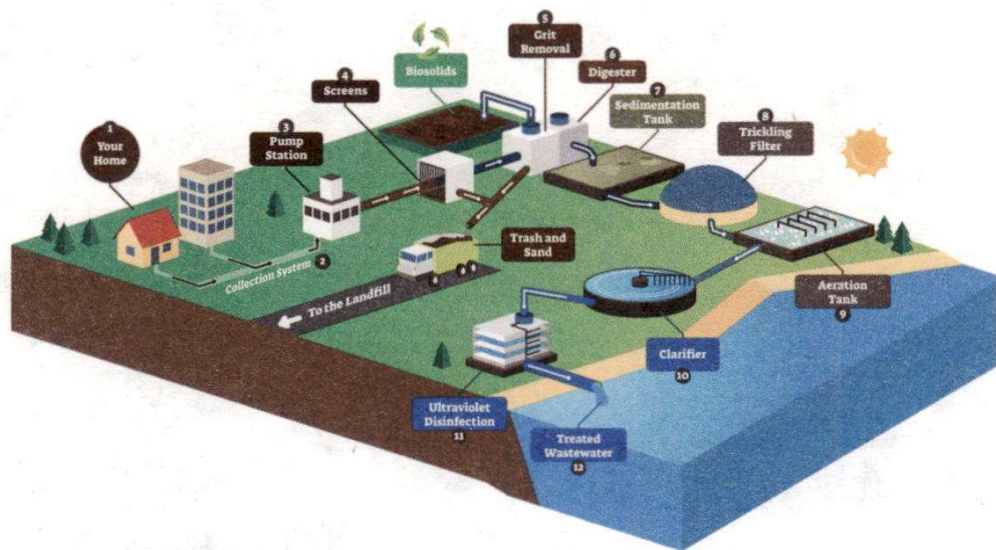

Like trash, a community must process wastewater in order to stay healthy. Water is a renewable natural resource. Even when it gets dirty, we can process it and make it clean again. If you live in a town, the wastewater from your home may go into a sewer system that delivers the dirty water to a wastewater treatment facility where it's cleaned and returned to the environment.

Learn how your community collects wastewater, where it goes, and how it is processed and then used again.



Date

Adult's Signature



## REQUIREMENT 3

### Investigate soil.

How does dirt clean water?  
Soil acts as a filter to protect the quality of water, air, and other resources.

Soil naturally filters water that falls as rain and goes into rivers. These same techniques are used to purify wastewater that comes from houses, cities, industry, and large animal feeding operations.

### SOIL INVESTIGATION EXPERIMENT

#### Materials

- ▶ Clear glass loaf pan or baking pan
- ▶ Powdered drink mix (red or purple in color)
- ▶ Sand
- ▶ Spray bottle filled with water
- ▶ Book or small block of wood

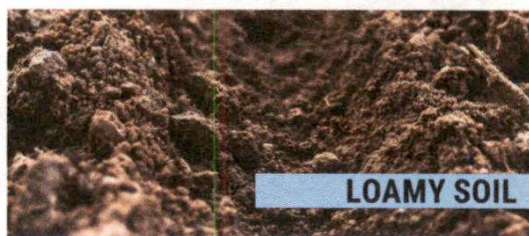

## Instructions

1. Make a small pile of powdered drink mix in one end of the clear glass pan.
2. Sprinkle sand over the rest of the pan.
3. Place the end of the pan with the powdered drink mix on top of the book or wood block so the pan is tilted.
4. Using the spray bottle of water, wet the sand, making sure it's really wet. Let it sit for a few minutes, and then wet it again.
5. Carefully lift up the pan and look underneath. What is happening?



Date \_\_\_\_\_

Adult's Signature \_\_\_\_\_



## REQUIREMENT 4

Investigate air pollution.

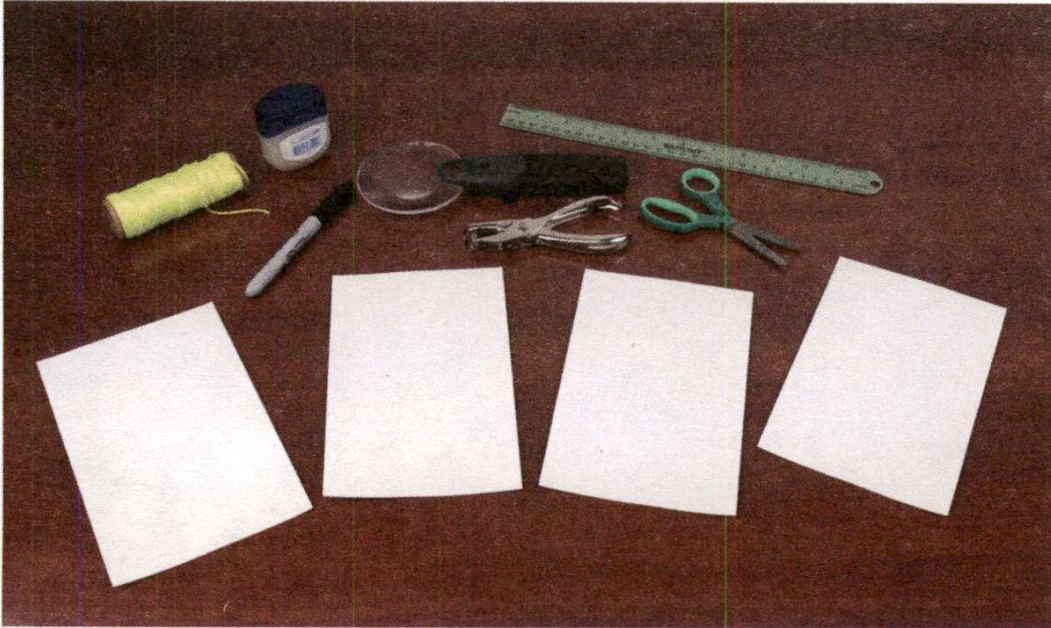

### Materials

- ▶ 4 index cards for each Bear Cub Scout
- ▶ Hole punch
- ▶ String
- ▶ Scissors
- ▶ Petroleum jelly
- ▶ Marker
- ▶ Magnifying glass

### Instructions

1. Draw a 2-by-2-inch square on each index card, and number each card with the marker.

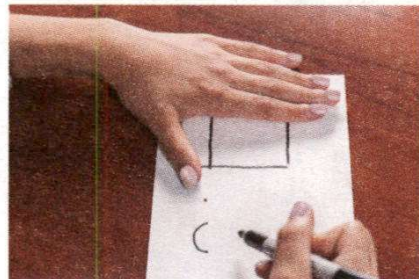

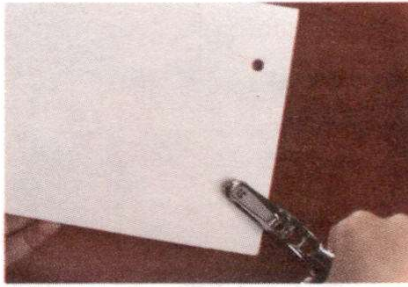

1. Punch a hole in the top corner of each index card and tie a string through each hole.

2. Smear petroleum jelly inside each square, and hang the index cards in different locations outside.

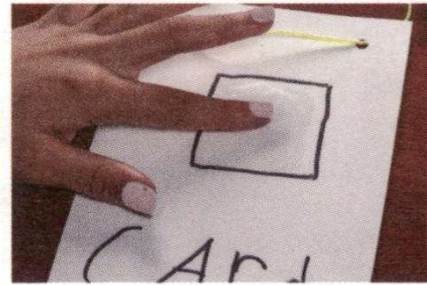

Allow the cards to hang, and observe them for a week.

3. Collect the index cards and examine your results. Using a magnifying glass, count the number of particles stuck to each index card. Record your observations below.

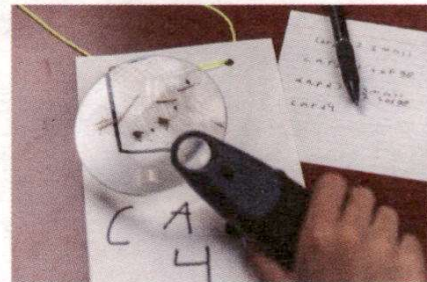

\_\_\_\_\_  
**CARD 1**

\_\_\_\_\_  
**CARD 2**

\_\_\_\_\_  
**CARD 3**

\_\_\_\_\_  
**CARD 4**



\_\_\_\_\_  
**Date**

\_\_\_\_\_  
**Adult's Signature**



## REQUIREMENT 5

Participate in a conservation project.

Conduct a conservation project with your den, pack, or family.

### Here are some ideas:

- ▶ Plant a tree. Select a native species that will do well in your location. Trees help filter the air and water.
- ▶ Add native plants to the landscape of your chartered partner or school. Native plants help the environment by providing resources that local animals and insects need.







- ▶ Create an informational flyer or poster that educates your community on how to reduce air pollution or wastewater. With the help of your den leader or adult partner, share your poster or brochure with your friends and neighbors.



Date

Adult's Signature



# CHEF TECH

ELECTIVE ADVENTURE





## SNAPSHOT OF ADVENTURE

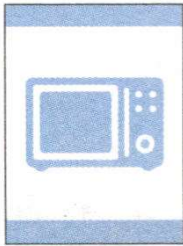

Cooking is a great way to see how technology has impacted our lives. As a Cub Scout, you may cook a hot dog using a stick on an open fire, which is the same way humans have cooked with fire for thousands of years. You could also cook a hot dog by boiling it in water in a pot on a stove. The fastest way to cook a hot dog is in a microwave in a matter of seconds. In this Adventure, we will explore technology in the kitchen.

### REQUIREMENTS

1. Pick a kitchen appliance that uses technology to complete the following requirements.
2. With an adult, review the safety guidelines in the owner's manual and follow all safety guidelines.
3. With adult supervision, download a cooking app or search online to find a recipe.
4. With adult supervision, follow the selected recipe and make the recipe.
5. Think of a way technology can improve the appliance used to make your recipe.



- [Elective Adventure](#)
- [Scan for this Adventure page](#)



# REQUIREMENT 1

Pick a kitchen appliance that uses technology to complete the following requirements.

A kitchen appliance is a machine that is used in the kitchen to prepare food. The most common appliances in a kitchen are an oven, stove, microwave oven, and toaster.

Other kitchen appliances include a mixer, blender, air fryer, waffle iron, and food processor.

Select an appliance that will be used to make a recipe that you choose in requirement 3.

Make sure the appliance you choose is in good working order.



**Safety:** If using a knife is required when making your recipe, you must first complete the Whittling Adventure.



\_\_\_\_\_ Date

\_\_\_\_\_ Adult's Signature



## REQUIREMENT 2

With an adult, review the safety guidelines in the owner's manual and follow all safety guidelines.

Every kitchen appliance has an owner's manual that gives you the instructions on how to use and take care of the appliance. If you don't have a physical copy of the owner's manual, you can find one online with help from an adult.



\_\_\_\_\_

Date

\_\_\_\_\_

Adult's Signature





### REQUIREMENT 3

With adult supervision, download a cooking app or search online to find a recipe.

Cookbooks are great, but technology now allows us access to all types of recipes. With help from an adult, use the internet to look for a cooking app or an online recipe. The best recipes found online will include video instructions.



Your recipe doesn't need to be complicated. It can be as simple as learning how to make a milkshake in a blender.



If the appliance you chose in requirement 1 is a cooking appliance, try finding a recipe that uses that appliance.



\_\_\_\_\_ Date

\_\_\_\_\_ Adult's Signature



## REQUIREMENT 4

With adult supervision, follow the selected recipe and make the recipe.

When you're ready to make your recipe, start by reading the recipe all the way through first. As you read, make sure you have the proper equipment.

Your first step is to make sure that the area you're working in is clean and that all the equipment you need is clean.

The next step is to gather the ingredients. Measure out what you need for the recipe. It is easier to measure everything you need at the beginning instead of measuring as you go.







Now follow the recipe's directions. If this is the first time making the recipe, you should follow it exactly. After you follow the recipe, you can make it special by adding changes the next time. For example, you may want more seasoning or want something to be sweeter.

When you're done, clean the area you were working in and clean all the kitchen tools, including the appliance you used. Watch for sharp edges when cleaning.



\_\_\_\_\_ Date

\_\_\_\_\_ Adult's Signature



## REQUIREMENT 5

Think of a way technology can improve the appliance used to make your recipe.

Now it's time to get creative and think of ways that the appliance you used could be improved. Here are some questions that may help you think of an improvement.

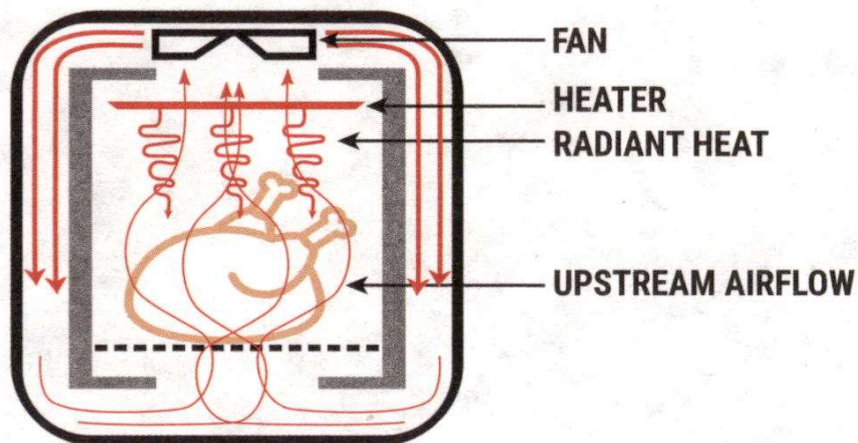

- ▶ Is there a way the appliance could work faster?
- ▶ Is there a way the appliance could be controlled more easily?
- ▶ Is there something that you had to do by hand that could be done by the appliance?
- ▶ Is there something that could make the appliance safer to use?



Date

Adult's Signature



# CRITTER CARE

ELECTIVE ADVENTURE





## SNAPSHOT OF ADVENTURE



Many Americans have a pet dog, cat, horse, bird, fish, hamster, or other animal. The most popular pet is a dog. Almost one out of three American households have a dog as a pet. One out of four have a cat as a pet.

Pets are fun, but they are also a big responsibility. Pets need food, water, shelter, and exercise to stay healthy. When you look after a pet, whether it belongs to you or a neighbor, you learn a lot about love, loyalty, and caring. Learning to look after pets — and having fun with them — is what this Adventure is all about.

### REQUIREMENTS

1. Identify an animal that would be a good pet for your family.
2. Choose two animals that are allowed as pets in your community. Compare and contrast why these pets may be a good choice for you.
3. Based on your choice in requirement 1, investigate how to properly care for your chosen animal.
4. Discover three ways a pet can help people.



- [Elective Adventure](#)
- [Scan for this Adventure page](#)



## REQUIREMENT 1

Identify an animal that would be a good pet for your family.

Every kind of pet needs a clean, dry place to sleep (except for fish, of course!). A dog might have a special place in your home where it sleeps. A horse might spend the day in a pasture and the night in a barn.



A hamster lives in a cage. A cat will make its own bed in a sunny spot by a window. Nutritious food, clean water, and plenty of exercise help keep pets healthy. Just like you, your pet will get sick if it eats nothing but junk food and never gets any exercise.

When you think of an animal for your family, first think of how your family would support a pet.

- ▶ What kind of shelter can you provide?
- ▶ How much space does the animal need?
- ▶ What type of food and how much food does the animal need?
- ▶ Who is going to be responsible daily for the well-being and care of the animal?
- ▶ Who will help play with the animal or take it on walks if it needs exercise?
- ▶ Is there a local veterinarian who can take care of the animals' health care needs?

A veterinarian can suggest the right food and exercise for your pet. Speaking of your veterinarian, most pets need regular checkups. Your veterinarian can help you make sure your pet stays healthy. A veterinarian can also give your pet vaccinations to prevent serious diseases. Your vet might even clean your pet's teeth.



\_\_\_\_\_

Date

\_\_\_\_\_

Adult's Signature



## REQUIREMENT 2

Choose two animals that are allowed as pets in your community. Compare and contrast why these pets may be a good choice for you.

Most communities have rules about what pets you may keep. Some communities allow you to keep a pig as a pet. You may find that there is a restriction on how many pets you may have in your home. For example, you may be allowed to have a dog but maybe not more than three dogs. To find out the rules in your community, check with animal control or your local government.



Choose two animals that are allowed as pets in your community. If the animal you chose in requirement 1 is allowed in your community, you may use that as one of the animals to compare and contrast. Look at the questions in requirement 1 and answer them for each animal. Based on those answers, which animal do you think would be happier with what you and your family can provide?



\_\_\_\_\_ Date

\_\_\_\_\_ Adult's Signature



## REQUIREMENT 3

Based on your choice in requirement 1, investigate how to properly care for your chosen animal.

Once you have identified an animal as a pet, do some further research about the animal. A veterinarian is a great resource. You may have a veterinarian visit your den. This person could share how to care for several different types of animals as pets.



Date

Adult's Signature



## REQUIREMENT 4

Discover three ways a pet can help people.

There are many ways pets can help people. Search-and-rescue crews use dogs to find people who are missing. Guide dogs help visually impaired people get around on their own. Therapy pets help people who are sad or who are



dealing with a lot of stress (like kids in the hospital). There are even dogs that can call for help if someone is having a medical emergency.







How have you seen animals at work? Can you think of other ways animals might help people?



\_\_\_\_\_

Date

\_\_\_\_\_

Adult's Signature





# FORENSICS

ELECTIVE ADVENTURE





## SNAPSHOT OF ADVENTURE



Everywhere you go, you leave behind clues: fingerprints on your juice glass, DNA on your toothbrush, bits of fabric on your favorite chair, and footprints in your yard. Criminals leave behind clues, too. Forensic scientists study those clues to help law enforcement officers solve crimes.

Forensics is all about using science to answer questions about crimes (and other things that have happened). In this Adventure, you will practice some of the skills of a forensic scientist.

You will analyze a fingerprint, a footprint, the contents of ink, and some mysterious white powder. Grab your magnifying glass and start detecting!

### REQUIREMENTS

1. Explore the term “forensics” and how it is used to help solve crimes.
2. Analyze your fingerprints.
3. Make a shoe imprint.
4. Do an analysis of four different substances: salt, sugar, baking soda and cornstarch.
5. Learn about chromatography and how it is used in solving crimes.
6. Find out how officers collect evidence.



- [Elective Adventure](#)
- [Scan for this Adventure page](#)



## REQUIREMENT 1

Explore the term “forensics” and how it is used to help solve crimes.

The word “forensics” comes from a Latin word that means “to make public.” Forensic scientists make information public that was hidden in plain sight.

Thanks to detective stories and crime shows on TV, many people know something about forensics. Talk with the other people in your family and den to find out what they know (or think they know) about forensics.

Write down any questions they have. As you do the other requirements for this Adventure, you might be able to answer some of those questions. With an adult’s supervision, you can also search the internet for sites that teach about forensics for kids.



Date

Adult’s Signature

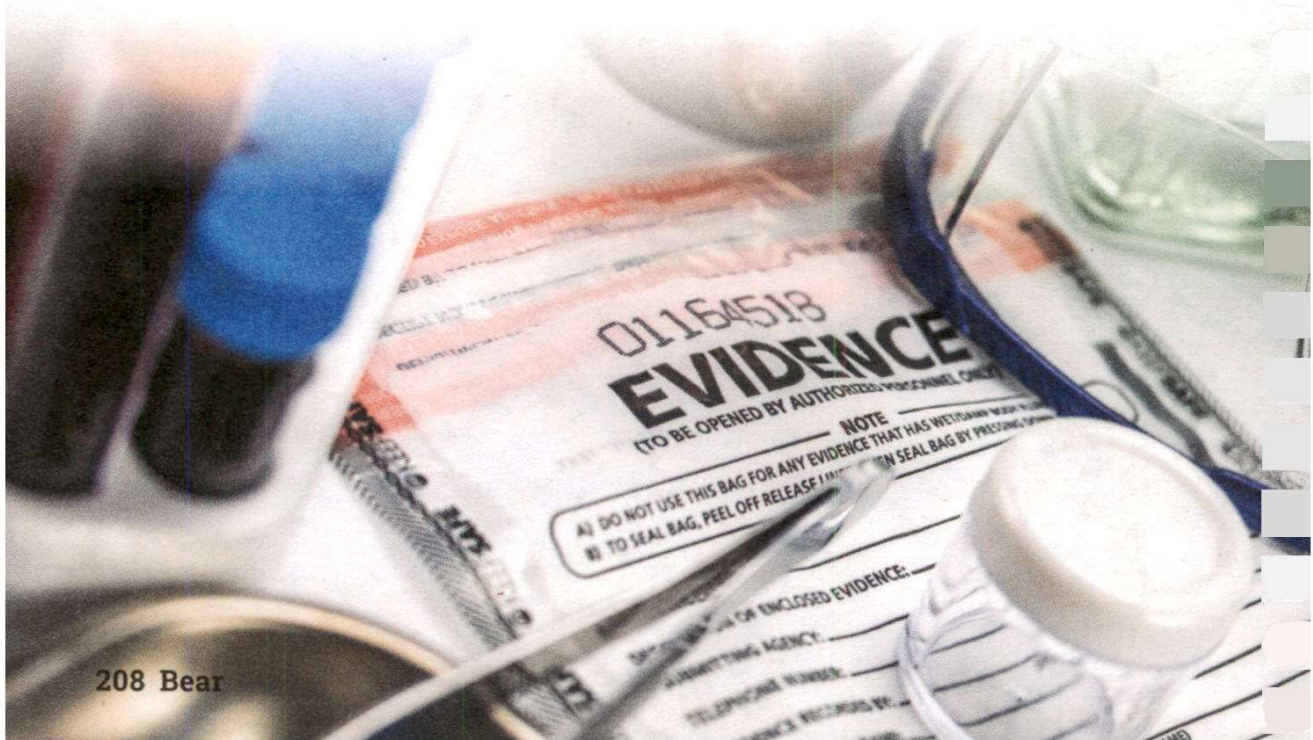



## REQUIREMENT 2

Analyze your fingerprints.

As you probably know, everybody's fingerprints are unique. Even identical twins have different fingerprint patterns! Police use fingerprints to identify criminals. Fingerprints are also used in other ways, like fingerprint scanners on laptop computers and smartphones. In this requirement, you'll discover what your fingerprints look like. You will need an ink pad and a magnifying



glass. Press the tip of one forefinger down on the ink pad so your fingertip is covered with ink. Press that finger straight down in the space on the next page, and then lift it straight up. (If you let it slide around, you'll get a smeared print.) Wait for the ink to dry. Be sure to wash your fingers!



LEFT

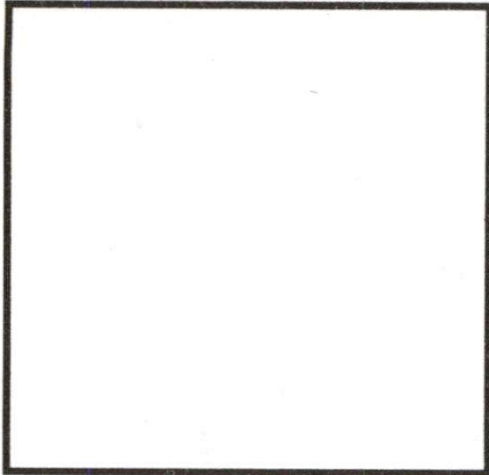

RIGHT

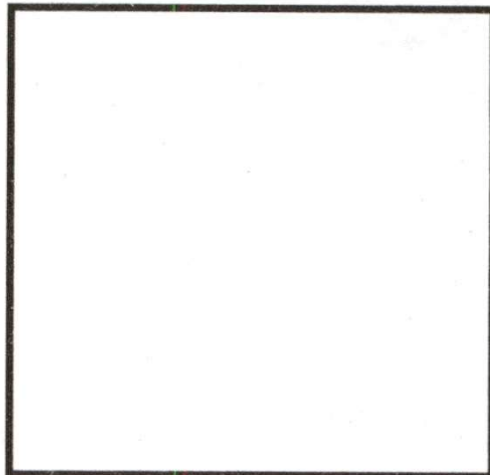

Using the magnifying glass, study the print you made. Do the ridges form an arch, a whorl, or a loop? Is the pattern short or tall? Does it lean one way or the other? How does it compare with the prints of others in your den or members of your family?



ARCH



WHORL



LOOP



Date

Adult's Signature

## REQUIREMENT 3

### Make a shoe imprint.

There is a lot of information you can get from just one shoe print. When you make your print, compare it to the other members of your den.

- ▶ How many different sizes are there?
- ▶ How many different types of shoes?
- ▶ Can you tell if a shoe is well worn?
- ▶ Are there two shoe prints that look exactly alike?



Chances are that each shoe print in your den is different. Even when two people have the same shoe, there are differences that a trained person can identify. How someone walks, how much they weigh, and even someone's height can be determined by a set of footprints.





### Materials

- ▶ An old worn shoe
- ▶ White paper
- ▶ Cooking spray
- ▶ Small paintbrush
- ▶ Cocoa powder, sand, or dirt
- ▶ Magnifying glass (optional)

### Instructions

Use an old shoe that you're not wearing, and lightly spray the bottom of it with the cooking spray. Press the shoe with the tread side down on the white paper, then carefully lift it away. Sprinkle a small amount of cocoa powder, sand, or dirt to the wet area. Shake off any excess powder. Look at your footwear impression closely with a magnifying glass and see if you can find any unique marks like cuts in the tread.



\_\_\_\_\_

Date

\_\_\_\_\_

Adult's Signature

## REQUIREMENT 4

Do an analysis of four different substances:  
salt, sugar, baking soda, and cornstarch.

Forensic chemists conduct tests to identify unknown substances. For example, they might add a chemical to the substance to see how it changes.

For this requirement, you'll analyze four common substances: salt, sugar, baking soda, and cornstarch. Use the chart on the next page to keep track of your results.

### Do these tests:

- ▶ Examine what the substance looks like, with both your unaided eye and with a magnifying glass.
- ▶ See how it feels when you rub it between your fingers.
- ▶ Sniff it to determine how it smells.
- ▶ Add a drop of water and, in a different spot, a drop of vinegar. Record how the substance reacts. Does it dissolve? Does it become hard?





	Salt	Sugar	Baking soda	Cornstarch
Appearance (naked eye)				
Appearance (magnifying glass)				
Feel between fingers				
Smell				
Reaction to water				
Reaction with vinegar				

After you've tested all the substances, ask your parent or a friend to give you a sample of one of the substances without telling you what it is. Can you identify it based on your test results?



\_\_\_\_\_

Date

\_\_\_\_\_

Adult's Signature

## REQUIREMENT 5

Learn about chromatography and how it is used in solving crimes.

Chromatography is a big word that means “color writing.” It is a technique for separating mixtures of different chemicals. Most chromatography is done in laboratories with expensive equipment, but you can do a simple experiment using materials found around your home. With these materials, you can separate the components of ink.

The pictures on the next page show what your investigations might produce. In this example, several different colors were hidden in the black ink. Chromatography causes the different pigments that make up the black ink to separate and spread out. Each formula used for black ink will create a unique spread of colors.

Forensic scientists do similar investigations on chemicals found at crime scenes. For example, using chromatography, they could identify the type of pen that was used to write a document.

### Materials

- ▶ A coffee filter
- ▶ Several nonpermanent felt-tip markers of different brands
- ▶ A glass of water
- ▶ Scissors
- ▶ Newsprint



## Instructions

1. Cut the coffee filter into strips an inch or so wide.
2. Draw a horizontal line across the middle of one of the strips.
3. Put the strip in the glass of water, making sure the line you drew is above the water.
4. Now watch what happens. The coffee filter will slowly absorb water, which will rise toward the top of the strip. As the water rises, it will carry along components of the ink. Lighter components will travel the longest distance; heavier components won't travel very far.
5. When the water nearly reaches the top of the strip (or when you don't see any more changes happening), take the strip out of the water and set it on a piece of newsprint to dry. Repeat the experiment with several pens. Compare the results to see how similar or different the inks you used are.

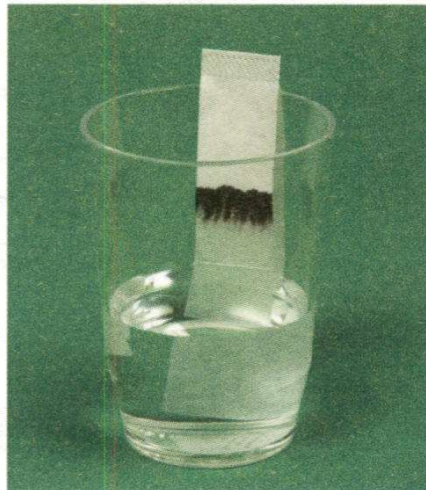
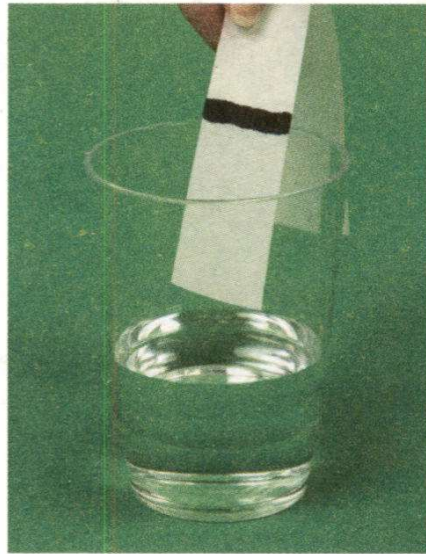
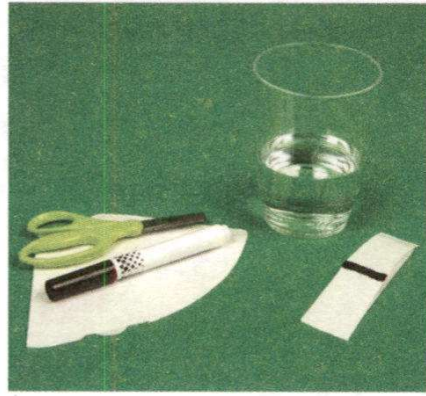

Date \_\_\_\_\_

Adult's Signature \_\_\_\_\_



## REQUIREMENT 6

Find out how officers collect evidence.

Law enforcement officers collect all sorts of forensic evidence. They interview witnesses. They check security camera videos.

Officers may work with other professionals to help collect evidence.

- ▶ A medical examiner performs autopsies to determine why people died.
- ▶ A toxicologist tests for poisons.
- ▶ A fingerprint expert identifies patterns in fingerprints.
- ▶ A forensic engineer tries to figure out how a structure collapsed.
- ▶ A multimedia scientist looks for clues in surveillance videos and crime-scene photos.







There are numerous jobs in the area of forensic science.

### K-9 UNITS

Did you know that dogs can serve as official law enforcement officers? You probably know that dogs have a really good sense of smell. Because of that, they can be trained to find all sorts of evidence, including blood and drugs that humans might not be able to detect.





Visit the library, explore the internet (with your parent's or legal guardian's permission), or talk with a law enforcement officer to learn more about how animals are used to gather evidence.

Your den or pack may schedule a visit to your local sheriff's office or police station. Find out how law enforcement officers look for and collect evidence.



\_\_\_\_\_

Date

\_\_\_\_\_

Adult's Signature



# LET'S CAMP

ELECTIVE ADVENTURE





## SNAPSHOT OF ADVENTURE



Camping is a fun way to spend time with family and friends. Prepare for your campout by gathering what you will bring with you and setting up a tent. Your den leader and parents will help you get ready. Find the best spot to pitch your tent and make it your home for the campout.

When you are camping, remember the Outdoor Code and Leave No Trace Principles for Kids found in the front of this book.

### REQUIREMENTS

1. Review the buddy system and how it works in the outdoors.
2. Pack your Cub Scout Six Essentials for the campout.
3. In addition to your Cub Scout Six Essentials, show the personal items you need for your campout.
4. Help set up a tent. Determine a good spot for the tent. Explain why you picked the spot.
5. Attend a council or district Cub Scout overnight camp or attend an overnight campout with your pack.



- Elective Adventure
- Scan for this Adventure page



## REQUIREMENT 1

Review the buddy system and how it works in the outdoors.

When you're on your campout, you need to have a buddy. The buddy system is the way Cub Scouts look after each other, especially on outdoor adventures. Having a buddy makes things more fun. When you see something amazing, a hawk catching a squirrel, a huge fish jumping in the lake, or a wild turkey spreading its feathers, share it with your buddy. It's great to have your buddy with you to help tell others about it.

Not only do you share experiences with your buddy, but you also keep each other safe. You keep track of what your buddy is doing, and your buddy knows at all times where you are and how you're doing.



\_\_\_\_\_ Date

\_\_\_\_\_ Adult's Signature

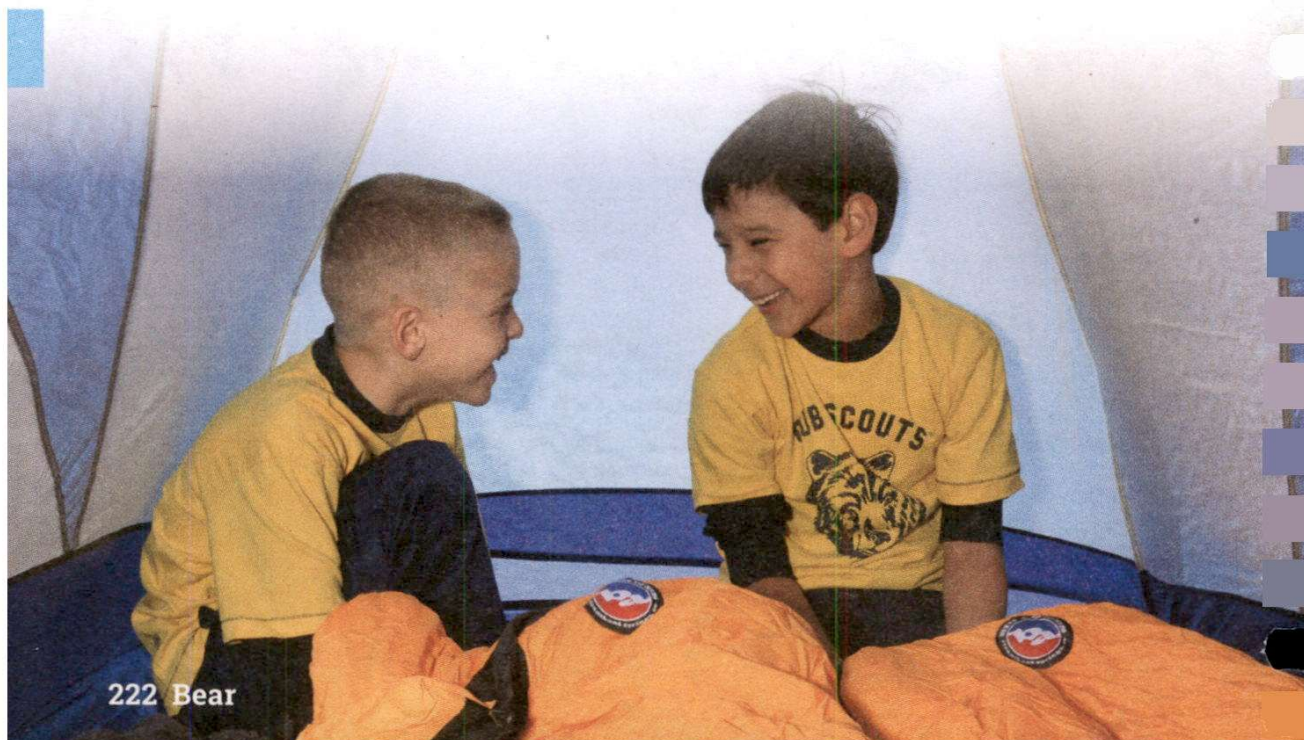

## REQUIREMENT 2

Pack your Cub Scout Six Essentials  
for the campout.

You bring the Cub Scout Six Essentials with you every time you're on an outdoor adventure. The Cub Scout Six Essentials are the first things you should have ready to pack for your campout.

### The Cub Scout Six Essentials are:

- ▶ Filled water bottle
- ▶ First-aid kit, including adhesive bandages, first-aid ointment, and other items
- ▶ Whistle
- ▶ Flashlight (Check the batteries)
- ▶ Sun protection
- ▶ Trail food

Check out the Cub Scout Six Essentials at the front of your handbook to learn more about them.



\_\_\_\_\_

Date

\_\_\_\_\_

Adult's Signature



## REQUIREMENT 3

In addition to your Cub Scout Six Essentials, show the personal items you need for your campout.

Make a complete list of what you need to bring. The list on the next page includes items you might want on a family or pack campout. Discuss with your pack or your family which items are needed.

### Make a check mark next to the items you plan to bring.

- |   |  |
|---|--|
| <input type="checkbox"/> Tent   | <input type="checkbox"/> Toothbrush & toothpaste   |
| <input type="checkbox"/> Sleeping bag or blankets<br>(to make blanket beds) | <input type="checkbox"/> Toilet paper  |
| <input type="checkbox"/> Sleeping pad or air<br>mattress                    | <input type="checkbox"/> Sweater or jacket   |
| <input type="checkbox"/> Underwear  | <input type="checkbox"/> Poncho or raincoat  |
| <input type="checkbox"/> Socks  | <input type="checkbox"/> Soap  |
| <input type="checkbox"/> Pajamas  | <input type="checkbox"/> Towel   |
| <input type="checkbox"/> Knife, fork, spoon                                 | <input type="checkbox"/> Extra pants and shirts  |
| <input type="checkbox"/> Plates, bowls, cups                                | <input type="checkbox"/> Extra pair of shoes   |
| <input type="checkbox"/> Trash bag  | <input type="checkbox"/> Bear Handbook   |
| <input type="checkbox"/> Insect repellent                                   | <input type="checkbox"/> Bible, testament, prayer<br>book, or another book for<br>your faith |

### GROUP EQUIPMENT CAN INCLUDE:

- A cooler to keep perishable foods cold
- Food for all camp meals
- Cooking pot or pan
- Wash and rinse pans
- Soap
- Disinfectant
- Plastic sheet for air-drying dishes
- Camp stove or charcoal
- Waterproof groundsheets
- Hammer for stakes
- Pliers

If you don't have everything you need for the campout, let your den leader know. Other Cub Scout families may have extra equipment you can borrow. Your equipment doesn't need to be expensive or fancy. You may need only an inexpensive plastic bowl to use for your campout. As you go camping more often, you can add to your equipment.

Before you leave on your outing, check off the list to make sure you have everything. Make sure your gear works and you have everything you need to set up.



\_\_\_\_\_

Date

\_\_\_\_\_

Adult's Signature



## REQUIREMENT 4

Help set up a tent. Determine a good spot for the tent. Explain why you picked the spot.

Where you set up your tent is an important part of being comfortable on a campout. Your tent should be in a flat area that is clear of low spots where water will collect if it rains. Look up at the trees. Don't set up your tent near trees that may fall or that have branches that may fall. Your tent should also be sheltered from strong winds. During cold weather, try to face the door of your tent away from the wind. Check for dead branches or trees near the tent site. If possible, use an existing tent site that is at least 100 steps away from water, roads, or trails. Check where your head will be when you sleep. You probably don't want it pointing downhill.







Before you set up your tent, move any rocks, sticks, or other hard objects from the tent site. These can damage the bottom of your tent. After you take down the tent, put back the objects you moved near where you found them. Also, pick up anything you and other campers brought to the campsite. Scouts always leave no trace!



\_\_\_\_\_

Date

\_\_\_\_\_

Adult's Signature



## REQUIREMENT 5

Attend a council or district Cub Scout overnight camp or attend an overnight campout with your pack.

If your pack wants to go on an overnight campout, at least one adult in your pack must take Basic Adult Leader Outdoor Orientation (BALOO) to organize and lead the overnight campout.

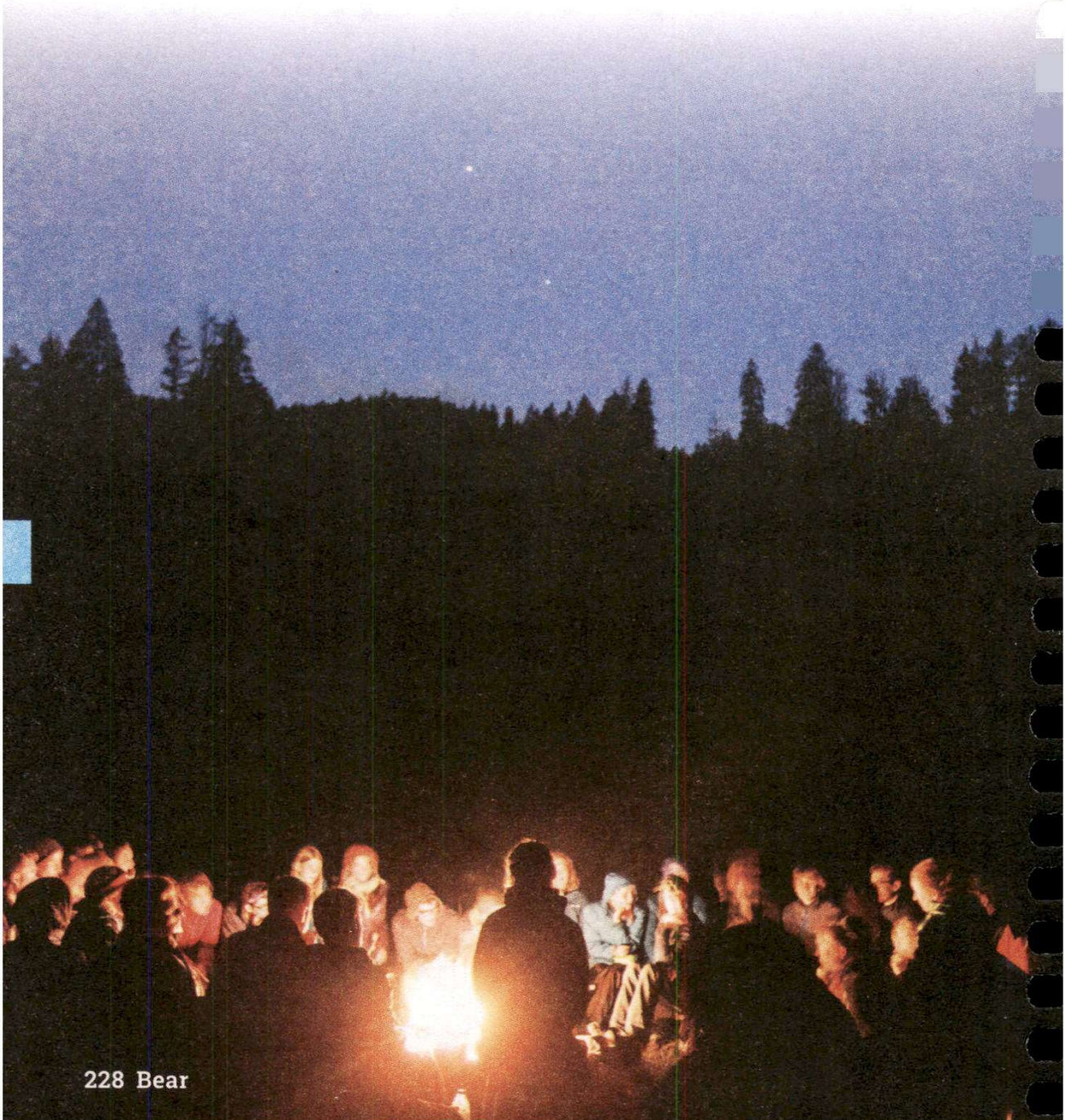





When you go on an overnight campout or any overnight activity as a Bear Cub Scout, at least one of your parents or legal guardian must attend with you. If one of your parents or legal guardian cannot attend, then have one of them speak to your den leader.



\_\_\_\_\_

Date

\_\_\_\_\_

Adult's Signature



# MARBLE MADNESS

ELECTIVE ADVENTURE

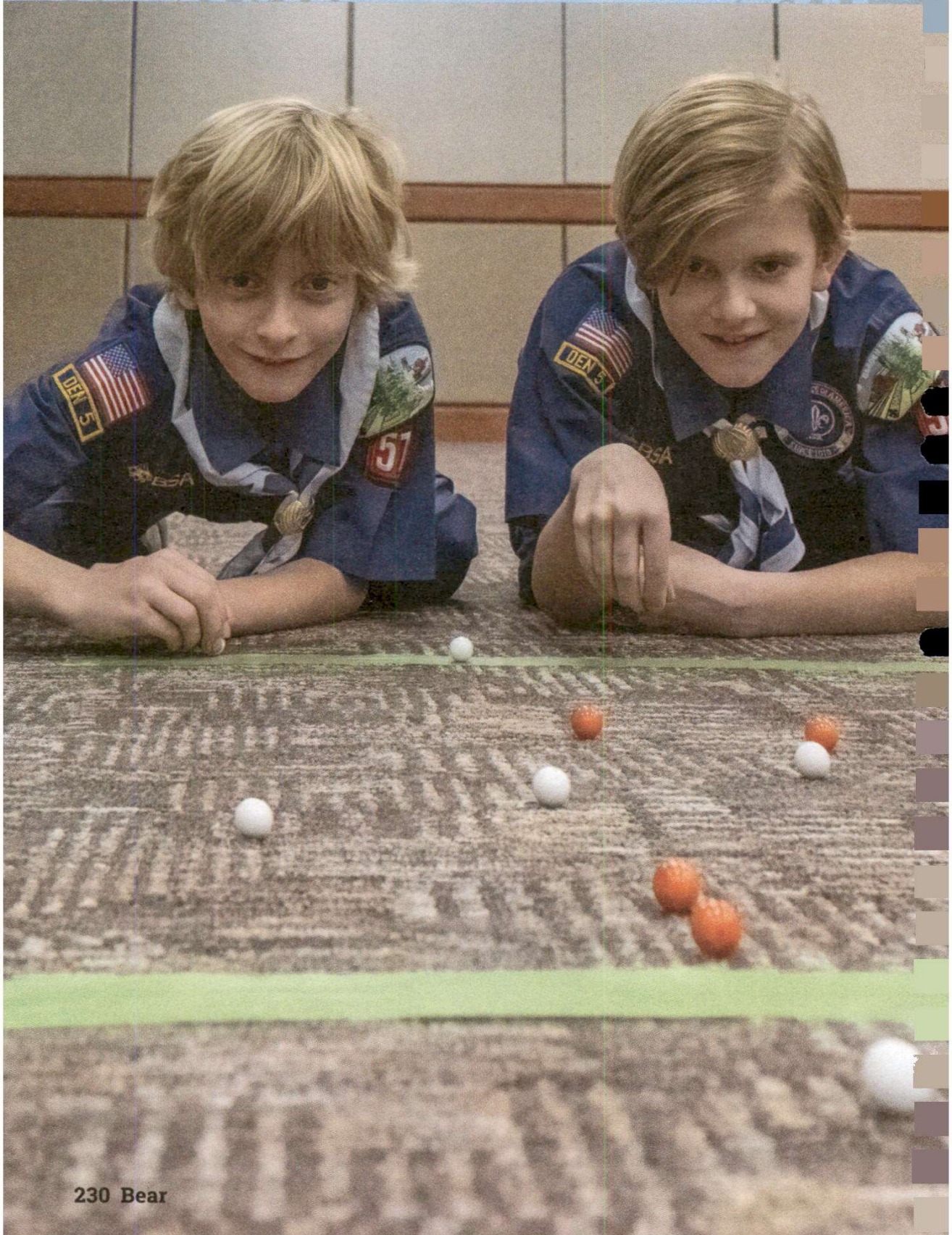



## SNAPSHOT OF ADVENTURE

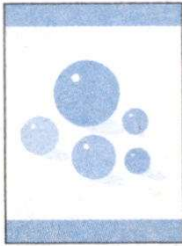

Long before board and video games, kids played with marbles. Those little balls of glass are just as fun to play with now as they were back then. In this Adventure, you'll play several different marble games. You'll also learn special words only marble players know and discover how to use marbles in mazes, obstacle courses, and more. Are you ready? Then grab your taws, aggies, and cat's eyes, and let's play marbles.

### REQUIREMENTS

1. Make a marble bag.
2. Learn five words that are used when talking about marbles.
3. Play three different marble games.
4. Build a marble racetrack with at least two lanes.
5. Build a marble maze.



- [Elective Adventure](#)
- [Scan for this Adventure page](#)



## REQUIREMENT 1

### Make a marble bag.

#### To make a drawstring bag to hold your marbles, you will need:

- ▶ A piece of fabric about 5 inches by 9 inches
- ▶ Needle and thread, for sewing by hand, or a sewing machine (and an adult to help operate it)
- ▶ A safety pin
- ▶ A shoestring or piece of cord about 3 feet long
- ▶ Scissors

#### DIRECTIONS

Fold the long ends of the cloth over about 1 inch and make a crease. Sew along the cut edges of the fabric to form two pockets.

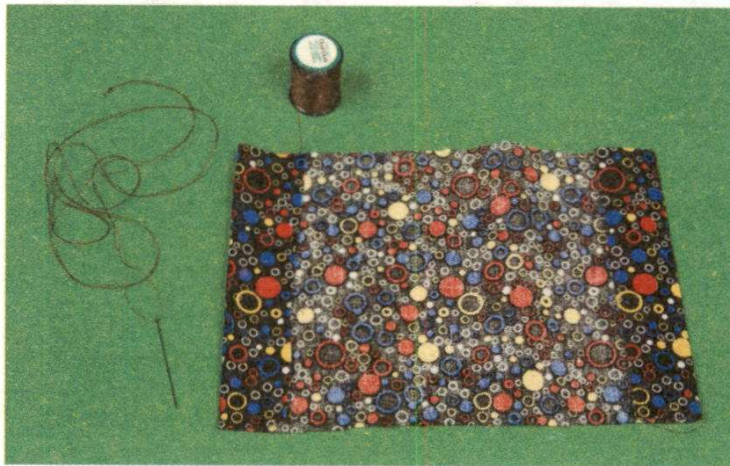

Fold the fabric in half so the printed side is on the inside. Sew along both edges — but not over the pockets you formed in step 1.

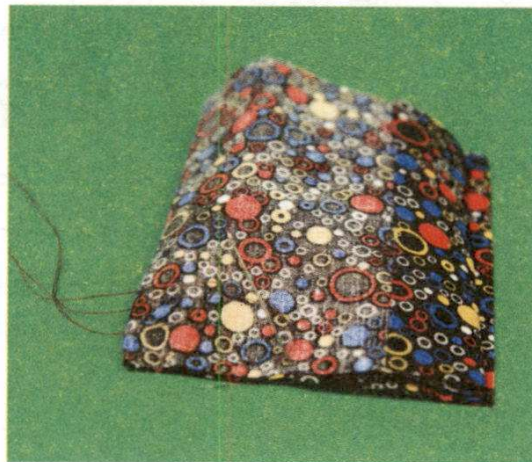



Attach the safety pin to one end of the shoestring or cord. Put the safety pin in the end of one of the pockets and push it through to the other end.

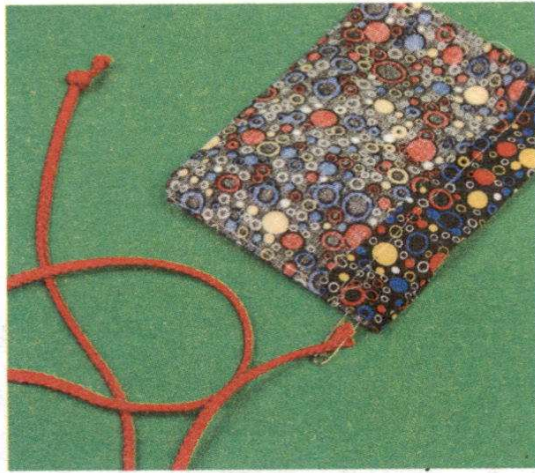

Next, put the pin in the closest end of the other pocket, and push it through to the other end. Remove the safety pin and tie the ends of the shoestring or cord in an overhand knot.

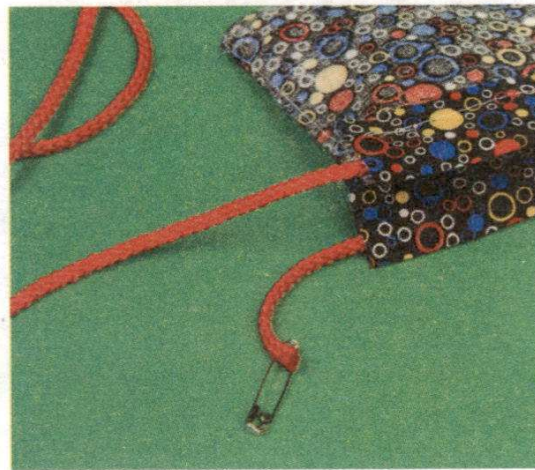

Turn the bag right side out. Fill the bag with marbles. To close it, scrunch the fabric at the top together and tie another overhand knot where the shoestring or cord comes out.

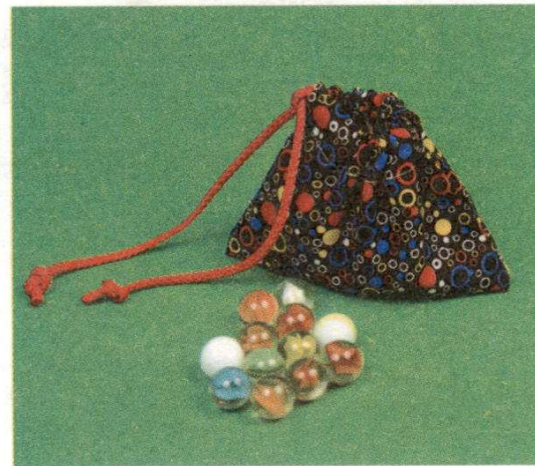

Date

Adult's Signature



## REQUIREMENT 2

Learn five words that are used when talking about marbles.

Marbles have been around for a long time. Your grandparents may have played marbles, and so did their grandparents. No one knows for sure where and when people started playing with marbles, but marbles have been found in Egyptian tombs and in pueblo ruins in the southwestern United States. Early marbles were stones, nuts, fruit pits, and other smooth, round objects.

### Here are some fun facts about marbles:

- ▶ When he was young, the Roman emperor Augustus played with marbles made of nuts.
- ▶ In 1503, the town of Nuremberg, Germany, passed a law that marbles had to be played outside the town limits.
- ▶ In the 1700s, people played using chips of marble, which is how the game got its name.
- ▶ In the early 1900s, marbles were made by machine for the first time.
- ▶ The British and World Marbles Championship has been played in Tinsley Green, England, every year since 1932, but the tradition began there in 1588.





**Here are some fun facts about marbles:**

- ▶ **Cat's eye** marbles have a swirl of color inside.
- ▶ **Taw marbles** are between one-half inch and three-fourths of an inch in diameter and are used as targets.
- ▶ **Alley marbles** are made of alabaster or marble. Some are made of glass to look like alabaster or marble.
- ▶ **Aggie marbles** are made of the mineral agate. Some are made of glass to look like agate. True aggies are good shooters because they are harder than other marbles.
- ▶ **Commie or common marbles** were originally made out of clay. They are the plainest looking marbles.

Like many games and sports, the game of marbles uses some special words. You have already learned some of them, like shooter and alley marbles.

**Here are some more:**

- ▶ **Bombies** is when you drop your marble onto another marble.
- ▶ **Duds** is when you knock two or more marbles out of the ring with one shot.
- ▶ **Keepsies** is when you keep the marbles you win in a game: Don't play for "keepsies" if you don't want to lose your marbles!
- ▶ **Friendlys** are when you give back the marbles you've won at the end of a game.
- ▶ **Knuckle down** is when you put one knuckle of your shooting hand on the ground as you shoot.
- ▶ **Histing** is when you lift your knuckle as you shoot.

What marble words do you and your friends use?



\_\_\_\_\_ Date

\_\_\_\_\_ Adult's Signature



## REQUIREMENT 3

Play three different marble games.

There are many different games of marbles, and each game has its own set of rules and directions. Here are three games to try.

### RINGER

You will need at least two players for this game.

- ▶ Draw a ring on the ground about 10 feet across.
- ▶ Put 13 marbles in the middle of the ring arranged in an X shape. They should be about 3 inches apart.
- ▶ The first player kneels outside the ring and uses their shooter to try to shoot a marble out of the ring. If it misses, the player's turn is over and they pick up the shooter. If the shooter hits and stays in the ring, the player can shoot again from where the shooter stopped. If the shot hits and the shooter goes out of the ring, the player's turn is over. The player keeps any marbles that go out of the ring.
- ▶ When the first player's turn is over, the second player takes a turn, etc.
- ▶ Keep playing until time is up or most of the marbles have been knocked out. The player with the most marbles is the winner.



## PLUMS

This game is for an even number of players.

- ▶ Draw two parallel lines about 6 feet apart.
- ▶ Each player puts the same number of marbles (called "plums" in this game) on one line a few inches apart. The players stand behind the second line.
- ▶ Players take turns shooting at the plums from behind the second line. They keep any plums they knock off the line.
- ▶ Keep playing until time is up, if a time limit has been set, or until all the plums have been picked. The player with the most marbles is the winner.



## DROPSIES

This game is good for two, three, or four players.

- ▶ Draw a square on the ground about 2 feet long by 2 feet wide.
- ▶ Each player places five marbles inside the square.
- ▶ The first player stands on one side of the square with their feet outside the line. That player drops a shooter from above waist height onto one of the other players' marbles to try to knock it out of the square. If that happens and the shooter stays in the square, the player keeps the marble that rolled out, and they get another turn. If a marble is knocked out, but the shooter also rolls out, the player keeps the marble that rolled out and their turn ends.
- ▶ Keep playing until time is up or most of the marbles have been knocked out. The player with the most marbles is the winner.

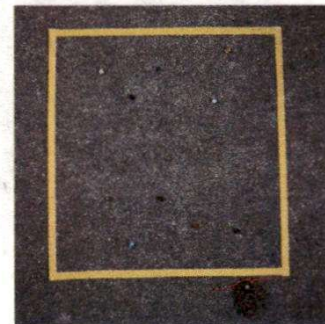

Date \_\_\_\_\_

Adult's Signature \_\_\_\_\_



## REQUIREMENT 4

Build a marble racetrack with at least two lanes.

See whose marbles are the fastest by creating a marble racetrack. You can make the lanes out of many materials, including felt board, cardboard, PVC pipe, or swimming noodles cut down the middle. For lane separators, use straws or small dowels. Don't forget to mark the start and finish lines.



\_\_\_\_\_ Date

\_\_\_\_\_ Adult's Signature





## REQUIREMENT 5

Build a marble maze.

A maze is a game in which you try to get from start to finish by navigating around a series of twists and turns. The more corners and dead ends the maze has, the more challenging it will be. Start with a flat surface. A box top works well because the lip around the edge will keep your marble from rolling away. Sketch your maze on the surface, and then glue straws or other dividers on the lines you've drawn. Once the glue has dried, you'll be ready to challenge the maze. How fast can you get through it?

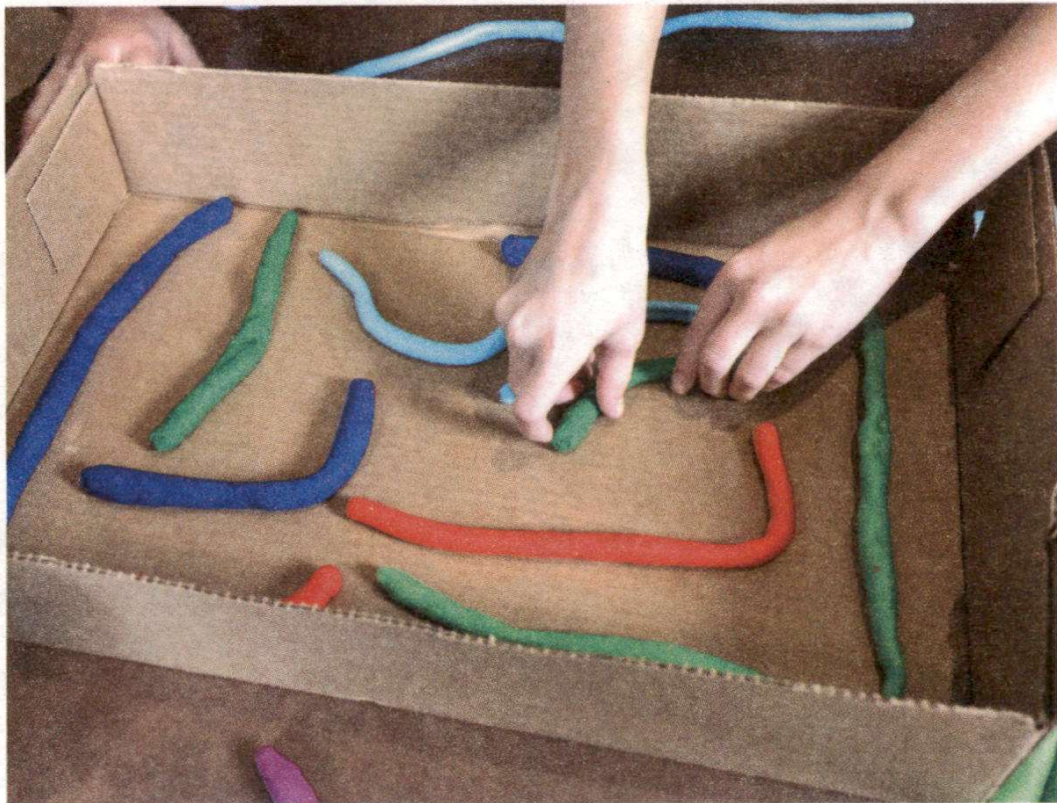

Date \_\_\_\_\_

Adult's Signature \_\_\_\_\_



# RACE TIME

ELECTIVE ADVENTURE





## SNAPSHOT OF ADVENTURE



There are many ways to make things go — electricity, fuel, and batteries, to name a few. Did you know that you have the power to make a boat sail in the water or that a car can move using the force of gravity?

Propulsion is what gives an object (such as a plane, car, or boat) the power to move. You will learn different ways to make and propel vehicles. Think about how the shapes of cars, boats, and planes affect the distance they can go. In this Adventure, you'll explore how you can use the air in your lungs, the force of gravity, and the power of your imagination to make things go.

### REQUIREMENTS

1. With an adult, build either a Pinewood Derby<sup>®</sup> car or a Raingutter Regatta<sup>™</sup> boat.
2. Learn the rules of the race for the vehicle chosen in requirement 1.
3. Identify how you could increase the speed of your chosen vehicle.
4. Before the race, discuss with your den how you will demonstrate good sportsmanship during the race.
5. Participate in a Pinewood Derby or a Raingutter Regatta.



- Elective Adventure
- Scan for this Adventure page



## REQUIREMENT 1

With an adult, build either a Pinewood Derby car or a Raingutter Regatta boat.

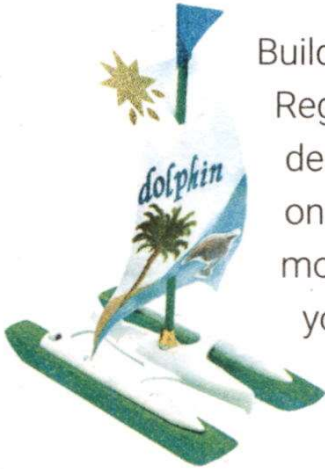

Building a Pinewood Derby car or Raingutter Regatta boat is a fun way to spend time with your den or family. Here are some basic instructions on how to make these fun vehicles. You may find more advanced tips and tricks with your den or family online.



### PINEWOOD DERBY CAR

A Pinewood Derby car is made out of wood and runs on a downward track. The car uses the force of gravity to run down the track. Read all the basic instructions first before starting to make your car.

#### Materials and Tools

- ▶ Pinewood Derby car kit
- ▶ Saw
- ▶ Hammer
- ▶ Sandpaper (200 grit)
- ▶ Paint
- ▶ Paint brushes

#### Instructions

##### 1. Draw a design for your car.

Take the block of wood in your Pinewood Derby car kit and place it on its side. Draw an outline of the wood on paper. Now draw the profile (side view) of your car.





**2. Cut out your car from the block of wood.** You can use a handsaw, or you can have an adult use a power tool to cut it out.



**3. Sand your car.** Sanding will remove any sharp corners and will allow paint or any other decoration you add to your car to stick better.

**4. Paint and decorate your car.**

Pinewood Derby cars are made of soft wood and when you paint them it may take a couple of layers or coats of paint. Paint the car once and then, when the paint is dry, use sandpaper to lightly sand it. Clean off any dust from sanding and paint it again. You can repeat this over and over until you get the look you want.



**5. Assemble your car.** Using the nails that came in your kit, attach the wheels that came in the kit to the car in the pre-cut areas on the bottom of the car.



**6. Check the weight.** Do this step last as everything else you do will either add or subtract weight from your car. You want your car to be exactly 5 ounces. If it weighs less, you can simply glue pennies to the car to get it just right.

**Here is a tip.** Make sure your axles are square at a 90-degree angle. This will keep your car straight when going down the track. If your axles are not square, your car may want to turn and rub up against the track, causing it to slow down. You can test your car by simply pushing it across the floor to see if it goes straight.



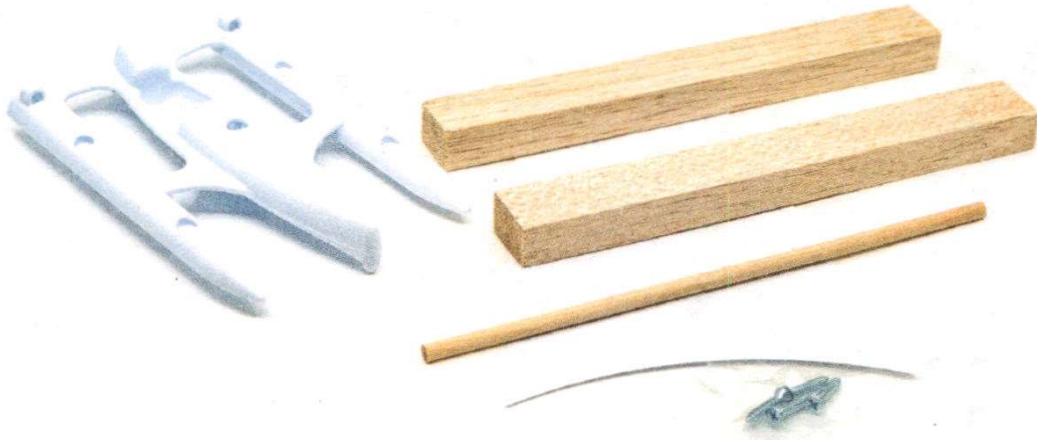

## RAINGUTTER REGATTA BOAT

The Raingutter Regatta kit comes with everything you need to make your boat. The Raingutter Regatta boat is raced in either a homemade track by capping the ends of two 10-foot-long rain gutters, or your pack may buy an inflatable track. Two Cub Scouts will race their boats by blowing into the sails.

### Materials and Tools

- ▶ Raingutter Regatta kit
- ▶ Phillips head screwdriver
- ▶ Sandpaper (200 grit)
- ▶ Paint
- ▶ Paint brushes
- ▶ Glue





## Instructions

**1. Sand the wooden hulls.** It is easier to sand the wooden hulls before you assemble your boat.



**2. Attach the plastic cabin to the two wooden hulls.**

**3. Paint and decorate your boat.** If you're painting, it's best to use a primer first. This will help the paint stick to the plastic parts of the boat. You can decorate the sail, too.

**4. Assemble the sail and mast.** Use a small bit of glue in the hole where the mast will go, then place the mast into the hole. Allow the glue to dry before you attach the sail.



Here is a tip. You can add wax to the bottom of your boat, the hull, to make it extra smooth. The smoother the hull, the faster your boat can go.



\_\_\_\_\_

Date

\_\_\_\_\_

Adult's Signature



## REQUIREMENT 2

Learn the rules of the race for the vehicle chosen in Requirement 1.

Rules are important so that everyone knows how to play. The rules to the Pinewood Derby or Raingutter Regatta should be kept short and simple so everyone can know and understand them. Rules for the Pinewood Derby and Raingutter Regatta are included in each kit. To learn more about Pinewood Derby or Raingutter Regatta, check out the QR codes below.



**Pinewood Derby**



**Raingutter Regatta**

Your pack may have additional rules. You should ask for these rules before you start building. Most of the rules about Pinewood Derby and Raingutter Regatta are about what you can and cannot do when building your car or boat.

Next is knowing how your race will be conducted. You may have a race with just the members of your den; the winner of each den then competes for the pack championship. Your pack may run races based on the fastest time. Understanding how your pack will conduct the race will help you understand what is going on during the race and how many times you might be racing.



\_\_\_\_\_ Date

\_\_\_\_\_ Adult's Signature

## REQUIREMENT 3

Identify how you could increase the speed of your chosen vehicle.

To know how to make your vehicle go faster, you'll need to know what things make it move. There are a lot of different ways to make your vehicle go fast, and each of those ways is based on a science known as physics. Physics is a branch of science that helps us understand how the universe and the things in the universe act. When you discover ways to make your vehicle go faster, you're exploring the physics of your vehicle.

There are things that your Pinewood Derby car, your Raingutter Regatta boat, or anything that moves have in common and help us understand how to make our vehicle go faster. They are force and friction.

In physics, a force is what causes the motion of an object to change its speed. If you take a ball and place it on the floor, it may roll around for a while but eventually, it will stay in one place. If the wind blows, the ball will move. The wind is the force causing the ball to move. If you kick the ball, your foot becomes the force causing the ball to move.

For the Pinewood Derby, there is only one force that is applied to your car. It is one of the most powerful forces in the universe: gravity. Gravity is the force that makes your Pinewood Derby car move. Gravity is the same for every Pinewood Derby car. You can't change gravity.

For the Raingutter Regatta, the force that makes your boat move is you, your breath, or an air pump. Each Cub Scout is different, and the force that they put on their boat will be different. You can change the force for each Raingutter Regatta boat by how much force a Cub Scout can apply to it.



Friction is a type of force. When a force is applied to something that is moving one way and the force is going another way, it is called friction. Use the ball as our example. When you kick a ball, the ball moves through the air. The air causes friction, slowing the ball down. Gravity acts on the ball, too, by pulling the ball toward the ground. Gravity is a form of friction.

Anytime something is moving, it is going to have some type of friction. You may not be able to get rid of all the friction, but you may discover ways to lower it.

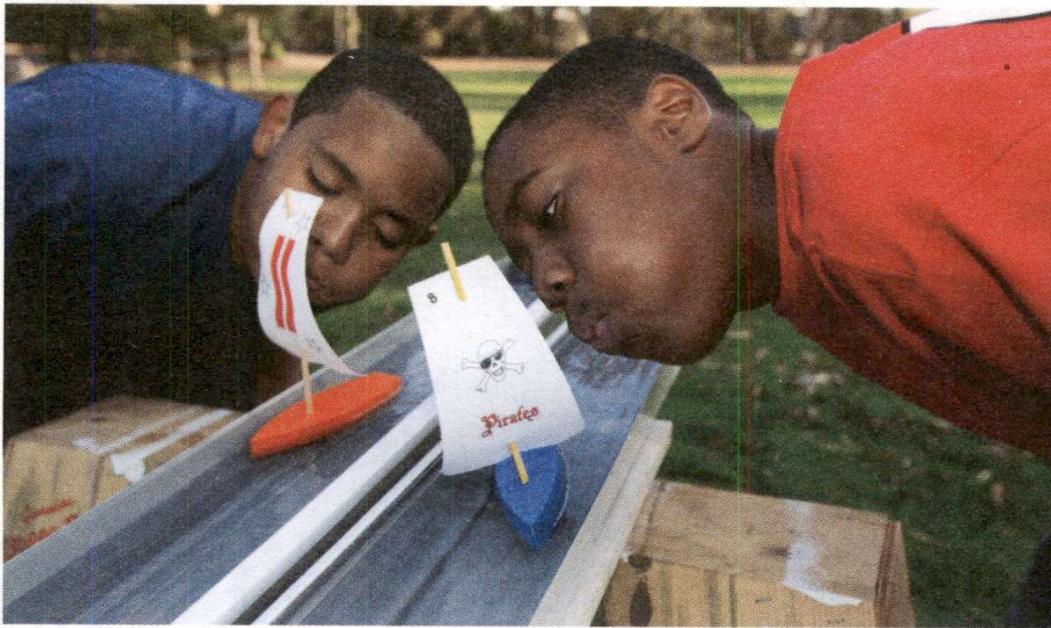

What could cause friction to the way your car moves down the track?

What could cause friction to the way your boat moves in the water?



Date

Adult's Signature



## REQUIREMENT 4

Before the race, discuss with your den how you will demonstrate good sportsmanship during the race.



Having a good time building your car or boat is what really matters. Just like any race, there is going to be someone with the fastest car or boat. Remember that the race is done to add excitement and fun. If you worked hard on your car or boat and can say that you did your best, then you have lived up to the Cub Scout Motto – “Do Your Best.”

Think about the Scout Oath and the Scout Law. With your den or family, point out the parts of the Scout Oath and the Scout Law that will be helpful for everyone to follow during the race.



\_\_\_\_\_ Date

\_\_\_\_\_ Adult's Signature



## REQUIREMENT 5

Participate in a Pinewood Derby or a Raingutter Regatta.

It's race day! Time to take everything you have learned in this Adventure and have a great time with your den or pack.





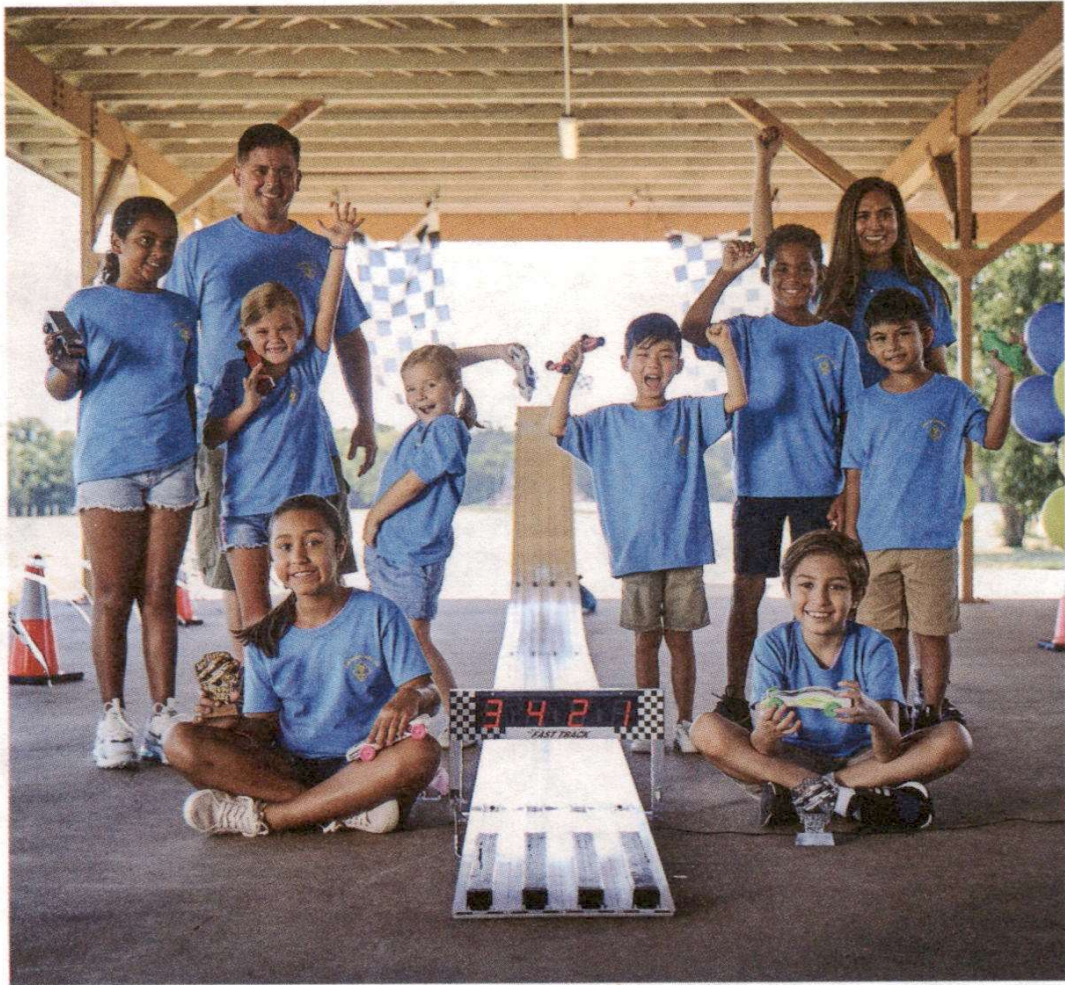

Date

Adult's Signature



# ROARING LAUGHTER

ELECTIVE ADVENTURE





## SNAPSHOT OF ADVENTURE



Laughing makes you feel good, and when you laugh others may start laughing, too. With just a smile, you can meet a new friend, make someone else smile, and create a happy feeling in yourself and other people. In this Adventure, you'll find lots of ways to smile and laugh.

### REQUIREMENTS

1. Think about what makes you laugh. Discuss these with your den or family.
2. Practice reading tongue twisters.
3. Play charades with your den or family.
4. Have a "funniest joke contest" with your den or family.
5. Practice "run-ons" with your den or family.



- Elective Adventure
- Scan for this Adventure page



## REQUIREMENT 1

Think about what makes you laugh. Discuss these with your den or family.



Everybody likes to laugh, but not everybody laughs at the same things. Did you know that laughing actually helps your body? It relaxes your muscles and makes your body and mind feel peaceful and calm. It helps your body fight off germs that could make you sick. It even improves blood flow in your blood vessels, which helps keep your heart functioning well. So laughter is just what the doctor ordered!

Think about what makes you laugh and make some notes.







## REQUIREMENT 2

Practice reading tongue twisters.

Tongue twisters are silly statements that trick your tongue. Some are easy to read, and others are really tricky — especially when you say them fast or repeat them. Tongue twisters can give you the giggles when the words that come out of your mouth are not exactly what you were trying to say.

Here are some examples of tongue twisters.

- ▶ A big black bug bit a big black bear. But where is the big black bear that the big black bug bit?
- ▶ How many yaks could a yak pack pack if a yak pack could pack yaks?
- ▶ How much wood could a woodchuck chuck if a woodchuck could chuck wood?
- ▶ How many cans can a canner can if a canner can can cans?
- ▶ Peter Piper picked a peck of pickled peppers. A peck of pickled peppers Peter Piper picked.
- ▶ If Peter Piper picked a peck of pickled peppers, how many pickled peppers did Peter Piper pick?
- ▶ She sells seashells by the seashore.



Check out *Scout Life* magazine's Think & Grin feature for more jokes and tongue twisters.



Date \_\_\_\_\_

Adult's Signature \_\_\_\_\_



## REQUIREMENT 3

Play charades with your den or family.



Charades is a game in which a person describes a person, place, or thing without talking. To start, divide the den or family into two teams. Choose someone to start the game.

The first person to start the game thinks of a person, place, or thing. It needs to be something that everyone knows. It could be a movie title. They then describe it without talking. They can use movements, gestures, or signals to communicate, but no words or sounds. This is called pantomime. The player pantomimes the word or phrase they chose to the other players to see if they can guess it.



Here are some common clues used in charades.

- ▶ To indicate a song title, pretend to sing into a microphone.
- ▶ To indicate a movie title, pretend to crank an old movie camera in front of your eyes.
- ▶ To indicate the number of words, hold up that many fingers. (Then hold up one finger before pantomiming the first word, two fingers before the second, and so on.)
- ▶ To pantomime a word that rhymes with the word you want players to guess, first tug on your ear to say, "sounds like."

Players from each team take turns pantomiming for their teammates. If the team guesses the word or phrase, the player or team gets a point. Play until each player has a turn to pantomime or set a time limit for the game.

Keep track of the points earned by each player or team. The one with the most points at the end of the game wins.



---

Date

Adult's Signature



## REQUIREMENT 4

Have a “funniest joke contest” with your den or family.

Everybody knows at least a few jokes. You can find lots of jokes in *Scout Life* magazine. You can even make up your own.

Here are some examples.

**Q:** What do you call a Cub Scout who carries another Cub Scout on their back?

**A:** A taxi Cub!

**Q:** How does a taxi Cub move?

**A:** Low-Cub motion!

**Q:** How did the Cub Scout look after forgetting to take a jacket on the mountain hike?

**A:** Blue and cold! (blue and gold)

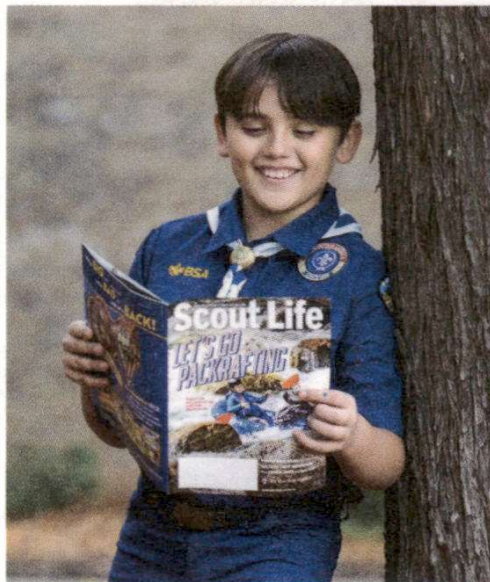

**Q:** What did the Cub Scout bake as den treats?

**A:** Cub-cakes!

**Q:** What did the Cub Scout neckerchief say to the Cub Scout hat?

**A:** You go on ahead; I'll hang around here.

**Q:** Why did the rubber chicken cross the road?

**A:** She wanted to stretch her legs.

**Q:** Why did the horse cross the road?

**A:** To reach his neigh-borhood.

You'll need a partner to ask the questions for knock-knock jokes.

**You:** Knock, knock.

**Your Partner:** Who's there?

**You:** Cows go.

**Your Partner:** Cows go, who?

**You:** No, silly. Cows go MOOO!



**You:** Knock, knock.

**Your Partner:** Who's there?

**You:** Interrupting Cow.

**Your Partner:** Interrupting C—

**You:** MOO!

**You:** Knock, knock.

**Your Partner:** Who's there?

**You:** Who.

**Your Partner:** Who, who?

**You:** Is there an owl in here?



**You:** Knock, knock.

**Your Partner:** Who's there?

**You:** Woo.

**Your Partner:** Woo, who?

**You:** Don't get so excited; it's just a joke.



**You:** Knock, knock.

**Your Partner:** Who's there?

**You:** Yodalayhi

**Your Partner:** Yodalayhi, who?

**You:** Hey, why are you yodeling?

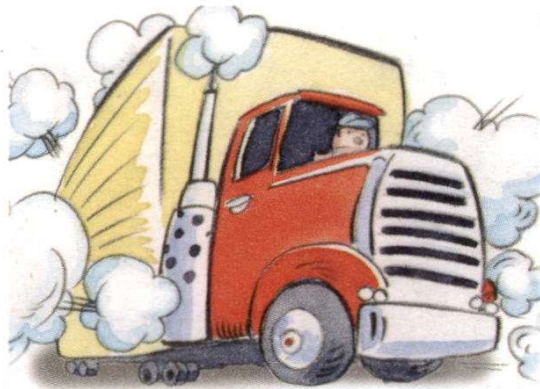

**You:** Knock, knock.

**Your Partner:** Who's there?

**You:** Cargo

**Your Partner:** Cargo, who?

**You:** Cargo vroom vroom.



\_\_\_\_\_ Date

\_\_\_\_\_ Adult's Signature

## REQUIREMENT 5

Practice "run-ons" with your den or family.

Run-ons are quick gags that are used during downtime at a campfire program or pack meeting. They can involve one person or many. When performing your run-on, remember to speak loudly and clearly so the audience can hear what you're saying.

Here are some examples:

**Scout 1:** Runs out screaming, "They're on me! They're on me!"

**Scout 2:** "What's on you?"

**Scout 1:** "My clothes."

**Scout 1:** Runs out screaming, "They're after me! They're after me!"

**Scout 2:** "Who's after you?"

**Scout 1:** "The squirrels. They think I'm nuts."

**Scout 1:** Walks out dragging a rope across the ground.

**Scout 2:** "Why are you dragging that rope?"

**Scout 1:** "Have you ever tried pushing one?"



\_\_\_\_\_

Date

\_\_\_\_\_

Adult's Signature







# SALMON RUN

ELECTIVE ADVENTURE





## SNAPSHOT OF ADVENTURE



Did you know that nearly three-fourths of the Earth is covered by water? It is! If you want to explore a lot of the world, you have to go by boat or know how to swim. Grizzly bears are animals that know how to swim even though they live in the forest. They swim in ice-cold rivers to catch the salmon they eat. As a Bear Scout, you will get to go swimming, too – not to catch fish, but to have fun. In this Adventure, you'll learn about swimming and boating and how to stay safe around the water.

This elective Adventure may be earned by completing the requirements below **OR** passing the BSA swimmer test **OR** taking swimming lessons.

### REQUIREMENTS

1. With your den or an adult, identify the attributes of qualified adult supervision at a swimming activity.
2. Learn the three swimming ability groups for the Boy Scouts of America and the water depths appropriate for each.
3. Go swimming with your den, pack, or family for 30 minutes using the buddy system.
4. Demonstrate the use of the buddy system, buddy checks, and ability groups with your den or an adult.
5. Attempt the BSA beginner swim test.
6. Demonstrate both a reach rescue and a throw rescue.



- Elective Adventure
- Scan for this Adventure page



## REQUIREMENT 1

With your den or an adult, identify the attributes of qualified adult supervision at a swimming activity.



When swimming, Cub Scouts follow BSA Safe Swim Defense guidelines. These are eight things you do to stay safe.

### 1. Qualified Supervision

All swimming activity must be supervised by a mature and conscientious adult age 21 or older who understands and knowingly accepts responsibility for the well-being and safety of those in their care, and who is trained in and committed to compliance with the eight points of BSA Safe Swim Defense. It is strongly recommended that all units have at least one



adult or older youth member currently trained in BSA Aquatics Supervision: Swimming and Water Rescue or BSA Lifeguard to assist in planning and conducting all swimming activities.

## **2. Personal Health Review**

A complete BSA Annual Health and Medical Record is required of all participants as evidence of fitness for swimming activities. Forms for minors must be signed by a parent or legal guardian. Participants should be asked to relate any recent incidents of illness or injury just prior to the activity. Supervision and protection should be adjusted to anticipate any potential risks associated with individual health conditions. For significant health conditions, the adult supervisor should require an examination by a physician and consult with the parent, legal guardian, or caregiver for appropriate precautions.

## **3. Safe Area**

All swimming areas must be carefully inspected and prepared for safety prior to each activity. Water depth, quality, temperature, movement, and clarity are important considerations. Hazards must be eliminated or isolated by conspicuous markings and discussed with participants.

## **4. Response Personnel (Lifeguards)**

Every swimming activity must be closely and continuously monitored by a trained rescue team on the alert for and ready to respond during emergencies. Professionally trained lifeguards satisfy this need when provided by a regulated facility or tour operator. When lifeguards are not provided by others, the adult supervisor must assign at least two rescue personnel, with additional numbers to maintain a ratio of one rescuer to every 5 Cub Scouts. The supervisor must provide instruction and rescue equipment and assign areas of responsibility as outlined in *Aquatics Supervision*. The qualified supervisor, the designated

response personnel, and the lookout work together as a safety team. An emergency action plan should be formulated and shared with participants as appropriate.

## **5. Lookout**

The lookout continuously monitors the conduct of the swim, identifies any departures from Safe Swim Defense guidelines, alerts rescue personnel as needed, and monitors the weather and environment. The lookout should have a clear view of the entire area but be close enough for easy verbal communication. The lookout must have a sound understanding of Safe Swim Defense but is not required to perform rescues. The adult supervisor may serve simultaneously as the lookout but must assign the task to someone else if engaged in activities that preclude focused observation.

## **6. Ability Groups**

All youth and adult participants are designated as swimmers, beginners, or nonswimmers based on swimming ability confirmed by standardized BSA swim classification tests. Each group is assigned a specific swimming area with depths consistent with those abilities. The classification tests must be renewed annually, preferably at the beginning of the season, even if the youth has earned the Swimming merit badge.

## **7. Buddy System**

Every participant is paired with one other. Buddies stay together, monitor each other, and alert the safety team if either needs assistance or is missing. Buddies check into and out of the area together. Buddies are normally in the same ability group and remain in their assigned area. If they are not of the same ability group, then they swim in the area assigned to the buddy with the lesser ability.



## 8. Discipline

Rules are effective only when followed. All participants should know, understand, and respect the rules and procedures for safe swimming provided by Safe Swim Defense guidelines. Applicable rules should be discussed prior to the outing and reviewed for all participants at the water's edge just before the swimming activity begins. People are more likely to follow directions when they know the reasons for rules and procedures. Consistent, impartially applied rules supported by skill and good judgment provide steppingstones to a safe, enjoyable outing.



\_\_\_\_\_

Date

\_\_\_\_\_

Adult's Signature

## REQUIREMENT 2

Learn the three swimming ability groups of the BSA and the water depths appropriate for each.

All youth and adults are designated as swimmers, beginners, or nonswimmers based on swimming ability confirmed by the BSA swim classification tests. Each group is assigned a specific swimming area with depths consistent with those abilities. The classification tests must be done at least annually.

The Cub Scout motto is "Do Your Best." In most situations, when a Cub Scout has done their best, they have met the requirement. For swimming ability groups, a Cub Scout must pass the test as described.

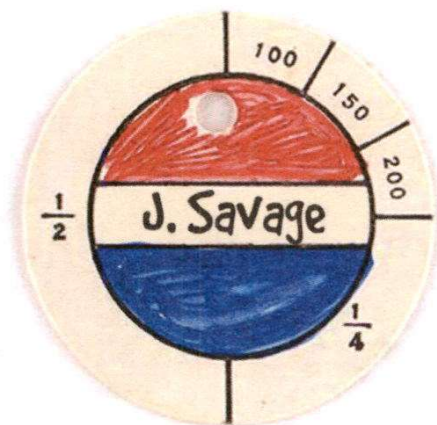

Swimmer

To be a **swimmer**, you must pass this test: Jump feet-first into water over the head in depth. Level off and swim 75 yards in a strong manner using one or more of the following strokes: sidestroke, breaststroke, trudgen, or crawl; then swim 25 yards using an easy, resting backstroke. The 100 yards must be completed in one swim without

stops and must include at least one sharp turn. After completing the swim, rest by floating.



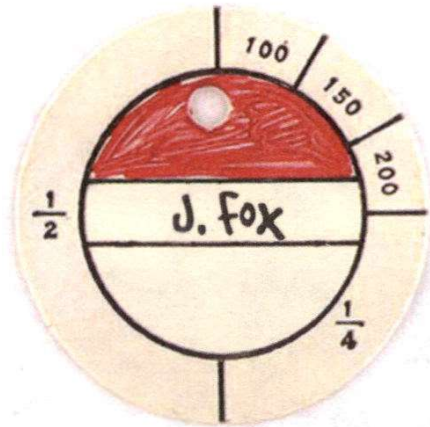

Beginner

To be classified as a **beginner**, you must pass this test: Jump feet-first into water over the head in depth, level off, and swim 25 feet on the surface. Stop, turn sharply, resume swimming, and return to the starting place.

Anyone who has not completed either the beginner or swimmer tests is classified as a **nonswimmer**.

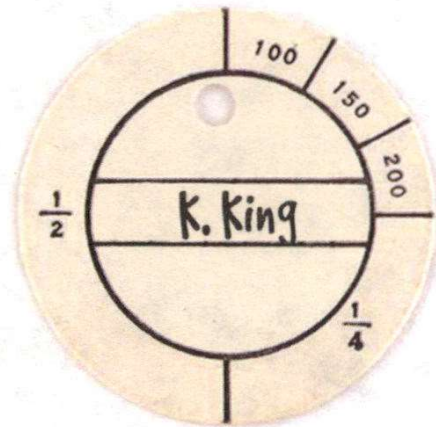

Nonswimmer

The nonswimmer area should be no more than waist to chest deep and should be enclosed by physical boundaries such as the shore, a pier, or lines. The enclosed beginner area should contain water of standing depth and may extend to depths just over the head. The swimmer area may be up to 12 feet in depth in clear water and should be defined by floats or other markers.



Date

Adult's Signature

### REQUIREMENT 3

Go swimming with your den, pack, or family for 30 minutes using the buddy system.



Whether you live in the city or the country, there is probably a place nearby you can go swimming. There may even be an indoor pool that is open year-round. For this requirement, visit a pool or swimming area with your den, pack, or family. Follow the rules on the next page to help keep you and your den or family safe.



\_\_\_\_\_ Date

\_\_\_\_\_ Adult's Signature



## REQUIREMENT 4

Demonstrate the use of the buddy system, buddy checks, and ability groups with your den or an adult.

Every participant, both youth and adults, are paired with another. Buddies stay together, monitor each other, and alert the safety team if either needs assistance or is missing.

Buddies check into and out of the area together. Buddies are normally in the same ability group and remain in their assigned area. If buddies are not of the same ability group, they swim in the area assigned to the buddy with the lesser ability.

A buddy check reminds participants of their obligation to monitor their buddies and indicates how closely the buddies are keeping track of each other. Roughly every 10 minutes, or as needed to keep the buddies together, the lookout, or other person designated by the supervisor, gives an audible signal, such as a single whistle blast, and a call for "Buddies." Buddies are expected to raise each other's hand before completion of a slow, audible count to 10. Buddies who take longer to find each other should be reminded of their responsibility for the other's safety.

Once everyone has a buddy, a count is made by area and compared with the total number known to be in the water. After the count is confirmed, a signal is given to resume swimming.



\_\_\_\_\_

Date

\_\_\_\_\_

Adult's Signature

# REQUIREMENT 5

Attempt the BSA beginner test.



For this requirement, you do not have to pass the beginner test — just do your best.

To be classified as a beginner, you must:

- ▶ Jump feet-first into water over your head in depth.
- ▶ Level off, and swim 25 feet on the surface.
- ▶ Stop, turn sharply, and resume swimming.

Try the test under the supervision of a lifeguard or other qualified adult. If you pass it, you'll be well on your way to swimming like a bear!



\_\_\_\_\_

Date

\_\_\_\_\_

Adult's Signature



## REQUIREMENT 6

Demonstrate both a reach rescue and a throw rescue.

Wherever you go swimming, a lifeguard should be on duty to help. They will help any swimmers who get into trouble. What if someone needs help and no lifeguard is around? As a Bear Scout, you're not expected to do the rescue work of a trained adult. However, there are some things you can do.

First, send a friend to call for help. Next, if no adult is there, try to help from shore or the edge of the pool. If the person is close to the edge, lie down and reach with your hand. Otherwise, use whatever is available, like a towel, a tree branch, a fishing pole, or a canoe paddle. Be careful not to let the person pull you into the water. If possible, anchor yourself to another person or to a solid object like the edge of a dock.





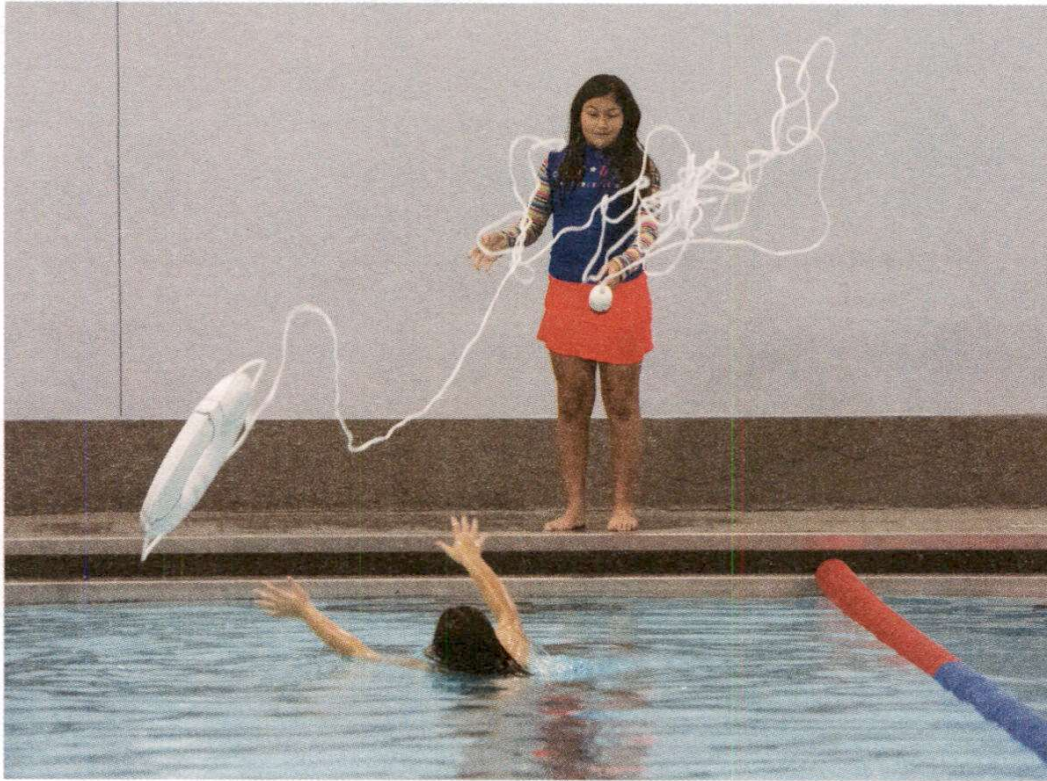

You can practice reach rescues in the shallow end of a swimming pool. If you are inside, you can pretend that a rug on the floor is the water.

If you can't reach the person, you can throw a rope, a life ring, or anything that will float. The object will give the person support. If it's tied to a rope, you can pull the person to shore. To practice throw rescues, you can create your own throw line at home. Just attach a rope to a plastic milk jug with a little water in it. Go outside and have a friend stand about 20 feet from you. Practice throwing the jug to your friend — but don't hit them with it!



\_\_\_\_\_

Date

\_\_\_\_\_

Adult's Signature







# SUMMERTIME FUN

ELECTIVE ADVENTURE





## SNAPSHOT OF ADVENTURE



The summertime is a great time to get together with your den or pack. The requirement for this Adventure is simple. Participate in three Cub Scout activities during the summer months. This can be at council-organized camps, like day camp or resident camp, or it can be a den or pack get-together for a summertime picnic.

To earn this Adventure as a Bear, you participate in summer activities during the summer after you completed the second grade. If you are just now learning about this Adventure don't worry – the requirement to earn it as a Webelos Cub Scout is exactly the same.

### REQUIREMENTS

1. Anytime during May through August participate in a total of 3 Cub Scout activities.



- Elective Adventure
- Scan for this Adventure page

## REQUIREMENT 1

Anytime during May through August participate in a total of three Cub Scout activities.

The summer is filled with fun Cub Scout activities. Below are just some things you, your den, or your pack may choose to do.



### **Cub Scout Day Camp**

Cub Scout day camps are held by local councils. Adults who serve as leaders for this camp are trained to put together fun activities. Day camp may be three to five days long. Each

day you arrive for a day filled with adventures and come home to share with your family what you did.

### **Cub Scout Resident Camp**

Cub Scout resident camps are held by local councils. Adults who serve as leaders for these camps are nationally trained and certified in all areas of camp. A resident camp takes place over several days and nights as you stay at camp the whole time, sleeping in a tent or other shelter.







### **A Pack-Organized Event**

Pack events during the summer may include a fun day at a park, a trek on a local trail, or a back-to-the-pack event right before school starts. It may even be an overnight campout.

### **A Den-Organized Event**

It can be fun to have your den get together for a visit to a museum, a zoo, or even a baseball game.



\_\_\_\_\_

Date

\_\_\_\_\_

Adult's Signature



# SUPER SCIENCE

ELECTIVE ADVENTURE





## SNAPSHOT OF ADVENTURE



Have you ever wondered why the sky is blue or how gravity works or what makes a rainbow? Scientists wonder about those things, too. Then, they figure out the answers using experiments.

## ANSWERING SCIENTIFIC QUESTIONS

Scientists try to create a fair test when they want to answer a question. The steps below can help you answer questions like a scientist.

1. Ask a question. (What do you want to discover?)
2. Do research. (What have other scientists already learned?)
3. Make a good guess at the answer. (This guess is called a hypothesis.)
4. Test your hypothesis with an experiment. (This is the fun part!)
5. Decide whether your hypothesis was supported by the information you collected.
6. Share what you discovered.

## REQUIREMENTS

1. Conduct a static electricity investigation.
2. Conduct the sink-or-float investigation.
3. Conduct the color-morphing investigation.
4. Conduct the color-layering investigation.



- [Elective Adventure](#)
- [Scan for this Adventure page](#)

## REQUIREMENT 1

Conduct a static electricity investigation.

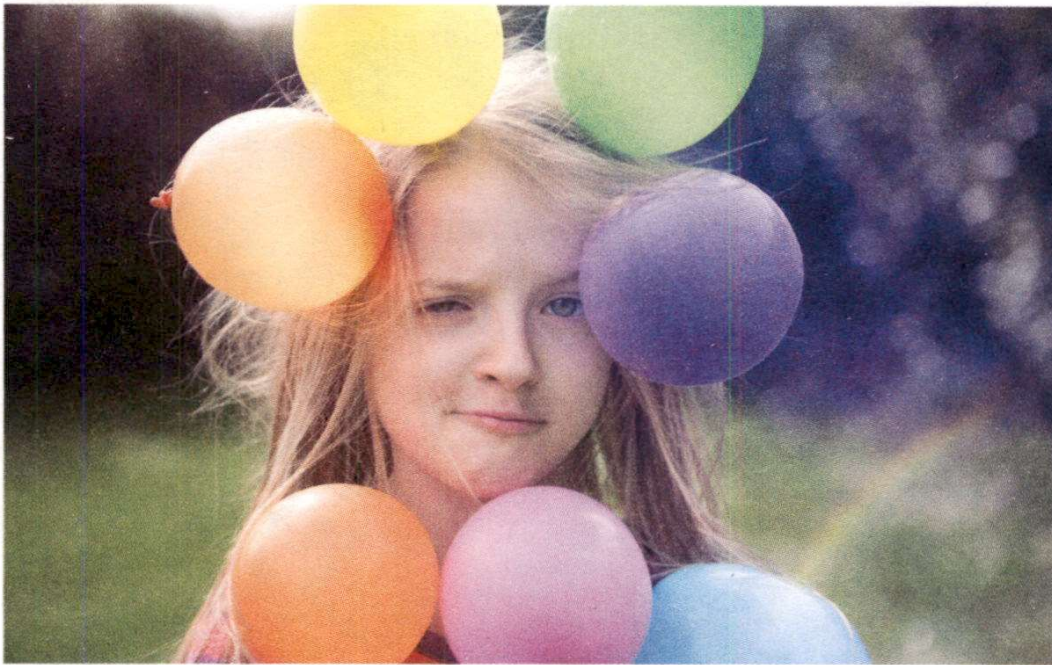

You may have walked across a carpeted floor to pet your dog and gotten a shock. You may have taken off your winter hat and found that your hair was standing straight up in the air. Those things happen because of static electricity.

To understand static electricity, you have to understand atoms. Everything around us is made up of very small things called atoms. Those atoms are made up of even smaller things, including protons and electrons. Protons have a positive charge, and electrons have a negative charge. Each atom usually has the same number of protons and electrons, but if two atoms bump into each other, electrons from one atom can get rubbed off onto the other atom.

As you walk across a carpeted floor (especially if you drag your feet), extra electrons build up on your body. When you touch your dog, those electrons jump onto the dog, causing a little spark of static electricity.



Why does your hair stand up when you pull off your winter hat? That happens because all your individual hairs now have a positive charge and are repelling each other. (This is like trying to hold the positive sides of two magnets together.)

Static electricity also makes some things stick together, such as hiking socks and dryer sheets. For this requirement, try to make objects stick to an electrically charged balloon or comb. Blow up a balloon or take a comb and rub each of them separately against a fleece blanket or wool sweater. Then see what objects will stick to the balloon or comb. Discuss your findings with your den.

### TESTING STATIC ELECTRICITY

Which of these objects will stick to a balloon or comb? Write down your prediction and then write down what actually happened.

Object	Prediction	Result of investigation
Tissue paper		
Aluminum foil		
Cardboard scrap		
Paper scrap		
Yarn or string		
Pom-pom		
Chenille stem		
Ribbon		
Cloth		
Foam		
Coin		

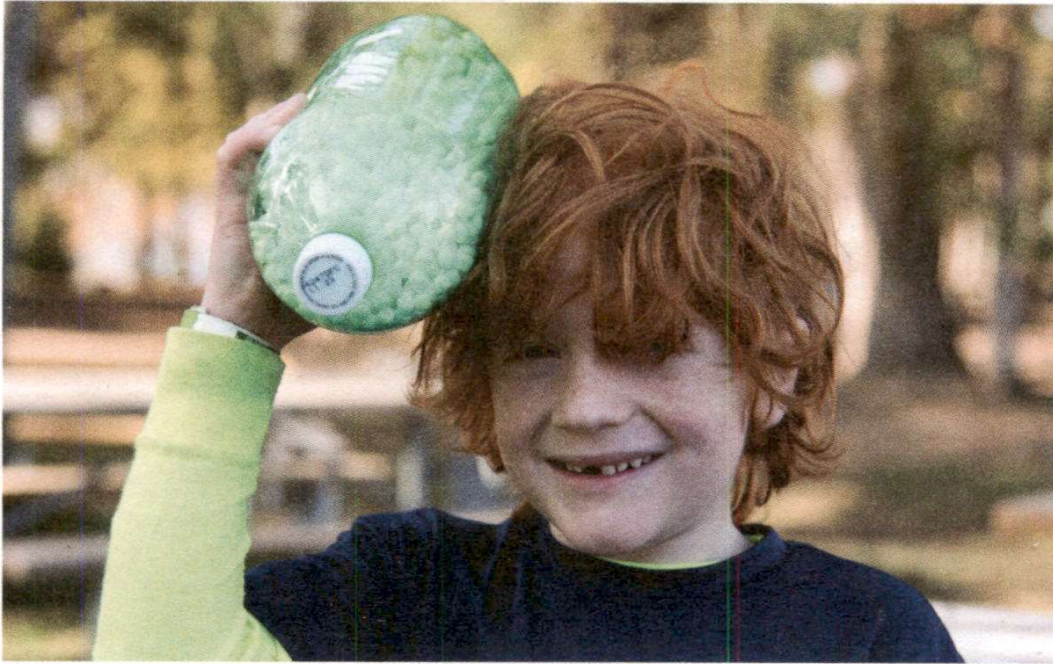

Another investigation into static electricity is to fill a dry, empty plastic bottle with small foam beads (like the kind in bean bag chairs). Stand in front of a mirror and rub the bottle on your head. What happens to the beads?

Now, touch your other hand to the bottle. Do the beads move toward your hand or away from it? Experiment with other objects to check the reaction of the foam beads.



\_\_\_\_\_

**Date**

\_\_\_\_\_

**Adult's Signature**



## REQUIREMENT 2

Conduct the sink-or-float investigation.

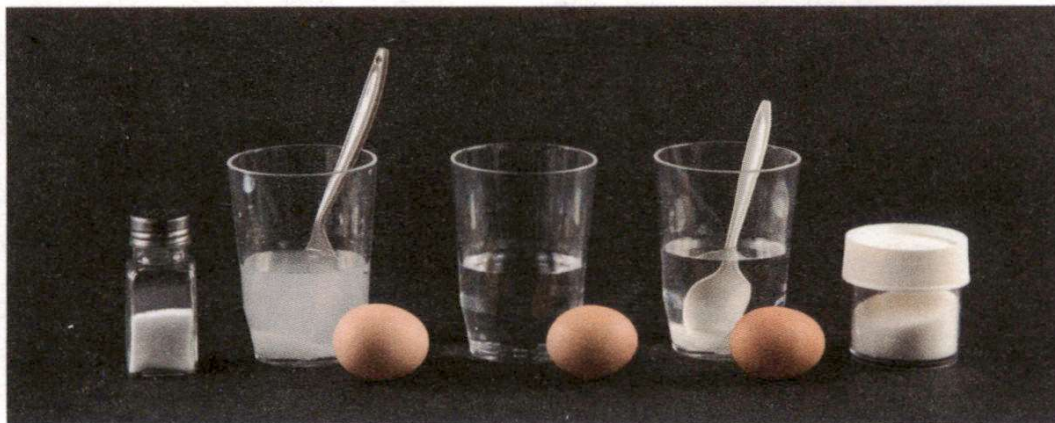

Have you ever wondered if an egg would sink or float? Do you think adding anything to the water would change the outcome? Let's find out.

### Materials

- ▶ Three large cups that hold about 12 ounces each, all the same size
- ▶ Three fresh eggs
- ▶ 2 tablespoons of salt
- ▶ 2 tablespoons of sugar
- ▶ Water
- ▶ A spoon

### Instructions

1. Fill all three cups half full of water.
2. Stir the salt into the first cup and the sugar into the second cup.
3. Leave the third cup alone.
4. In the chart on the next page, write down what you think will happen when you add an egg to each cup.
5. Add an egg to each cup. Observe what happens to each egg and write down the results.

## SINK OR FLOAT

Will salt or sugar affect whether an egg floats? Write down your prediction, and then write down what actually happened.

Object	Prediction	Result of experiment
Cup 1 – Salt added		
Cup 2 – Sugar added		
Cup 3 – Nothing added		

How did your predictions compare to what you observed? Why do you think the eggs did different things?

This investigation shows how scientists use variables. A variable is something that changes. By changing just one variable at a time, you proved how sugar and salt affect how eggs float.

The plain water is called the control because it doesn't change. Since the control is the same in each cup, we can use it to compare the results with the salt and the sugar.



Date

Adult's Signature



## REQUIREMENT 3

Conduct the color-morphing investigation.



You may have heard that oil and water don't mix. In fact, they will actually push away from each other if they are in the same space! To investigate this principle, you'll mix some food coloring into oil.

### Materials

- ▶ A large jar or clear vase
- ▶ Water to fill the jar halfway
- ▶ A measuring cup
- ▶ A spoon
- ▶ 2 tablespoons of cooking oil
- ▶ 3 drops each of red, blue, and yellow liquid food coloring

### Instructions

1. Fill the jar or vase halfway with water.
2. In the measuring cup, mix the oil and the food coloring together.
3. Pour this mixture slowly into the water and watch what happens. What is happening? Since food coloring is water-based, it will separate from the oil and float through the water in amazing color morphs. If you have time, try different color combinations.



Date

Adult's Signature

## REQUIREMENT 4

Conduct the color-layering investigation.

For this requirement, you'll create a rainbow in a cup using sugar, water, and food coloring.

### Materials

- ▶ 15 tablespoons of sugar
- ▶ 15 tablespoons of warm water
- ▶ Red, green, blue, and yellow liquid food coloring
- ▶ Six clear cups
- ▶ A spoon

### Instructions

1. Put five cups in a row on the table.
2. Add one tablespoon of sugar to the first cup, two tablespoons to the second cup, three to the third, four to the fourth, and five to the fifth.
3. Add three tablespoons of lukewarm water to each cup. Stir until most of the sugar dissolves.

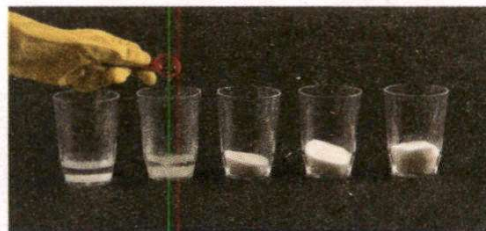
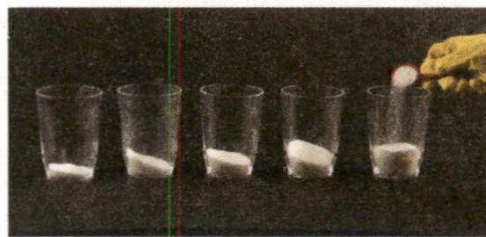
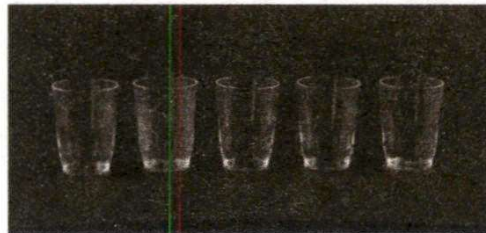



4. Add a drop or two of food coloring to the first four cups, one color per cup. In the fifth cup, mix two colors.



5. Take the fifth cup (the one with the most sugar) and pour half of its contents into the sixth cup (the one that's empty).



6. Hold the spoon, bowl side up, against the inside of the sixth cup. Slowly and gently pour half the contents of the fourth cup onto the spoon. (Pouring onto the spoon keeps the two liquids from mixing in the cup.) Do the same thing with the third, second, and first cups.



What is happening? Adding sugar to the water causes it to become denser as the sugar molecules take over the space. The more sugar you add, the denser the water becomes. That's why you can "stack" the colored water as long as you pour it gently.



Date

Adult's Signature



# WHITTLING

ELECTIVE ADVENTURE





## SNAPSHOT OF ADVENTURE



A pocketknife is a useful tool to have for Scouting activities. It can also be dangerous if you don't use it the right way. In this Adventure, you will learn how to use a pocketknife safely. You will also get to learn the basics of carving.

Completing the Whittling Adventure allows you as a Bear Scout to use a knife, with adult permission, during Cub Scout activities.

Your pocket certificate for this Adventure may serve as proof you have earned this Adventure.

Next year as a Webelos Scout you will need to earn the Chef's Knife Adventure to use a knife, with adult permission, during Cub Scout activities.

### REQUIREMENTS

1. Read, understand, and promise to follow the "Cub Scout Knife Safety Rules."
2. Demonstrate the knife safety circle.
3. Demonstrate that you know how to care for and use your pocketknife safely.
4. Make two carvings with a pocketknife.



- [Elective Adventure](#)
- [Scan for this Adventure page](#)

## POCKETKNIVES

Pocketknives come in all shapes and sizes. Some can be used for many different tasks. Others are designed for special purposes like fishing. Three common designs used in Scouting are the jackknife, the penknife, and the multipurpose knife. Let's look at each type.

### Jackknife

A jackknife is a good tool when camping and fishing. It is hinged at only one end and may have one or two blades. Sometimes one blade has a very sharp point, while another blade has a more rounded point. Some jackknives (and



other knives) have locking blades. That means you have to push a release before you can close the blade. Locking blades prevent you from accidentally closing the blade on your fingers.

### Penknife

A penknife is small and lightweight, so it is easy to carry in your pocket. It is hinged at both ends and usually has one or two blades at each end. Penknives were originally designed to cut or sharpen quills used for writing. Thomas Jefferson wrote the Declaration of Independence with a quill pen.

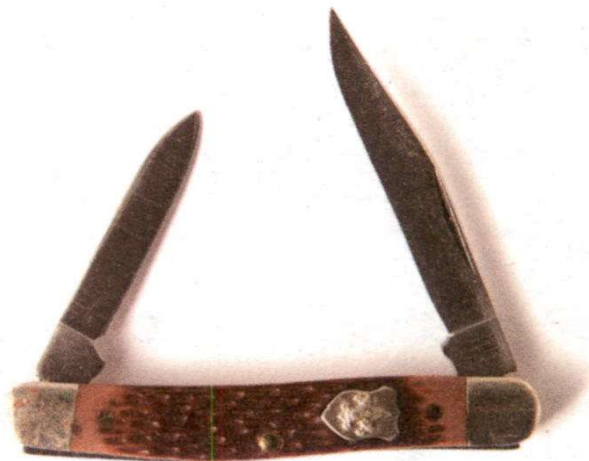



## Multipurpose Knife

Multipurpose knives can be used to do many things. In addition to one or two blades, a multipurpose knife might include a can opener, scissors, leather punch, tweezers, and screwdrivers. These knives can be fun to have, but all those extra pieces can get in your way when you're just trying to carve or cut some string. Also, the more tools your knife includes, the heavier it will be. Pick a multipurpose knife that has only the tools you really need.



## REQUIREMENT 1

Read, understand, and promise to follow the  
"Cub Scout Knife Safety Rules."

There are four Cub Scout Knife Safety Rules that focus on knife safety. Your parent, den leader, and other adults may have additional rules you must follow.

### CUB SCOUT KNIFE SAFETY RULES

**Stop** – make sure no one else is within arm's reach by making a knife safety circle

**Away** – always cut away from your finger or other body parts

**Sharp** – a sharp, clean knife is a safe knife

**Store** – knives closed, in a sheath or knife block

Source: American Knife and Tool Institute

### OTHER RULES I MUST FOLLOW

---

---

---

---

---



\_\_\_\_\_ Date

\_\_\_\_\_ Adult's Signature



## REQUIREMENT 2

Demonstrate the knife safety circle.



Make a safety circle. Before you pick up your knife to use it, stretch your arm out and turn in a circle. If you cannot touch anyone or anything else, it's safe to use your knife. While using your knife, be sure to watch in case someone walks toward you and gets too close.



\_\_\_\_\_

Date

\_\_\_\_\_

Adult's Signature

## REQUIREMENT 3

Demonstrate that you know how to care for and use your pocketknife safely.

### KEEPING YOUR KNIFE SHARP

A good way to sharpen your knife is to use a sharpening stone. Lay the blade on the stone at a slight angle. Push the blade forward as if you were going to shave a thin sliver from the stone.

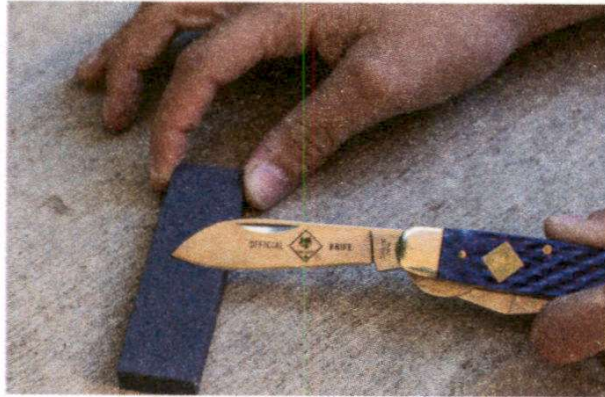

Do not push down hard. Next, turn the blade over and shave the stone toward you. This is the only time you should move your knife toward yourself. Keep your fingers below the surface of the stone to protect them. Continue this back-and-forth action until the edge is sharp along its entire length.

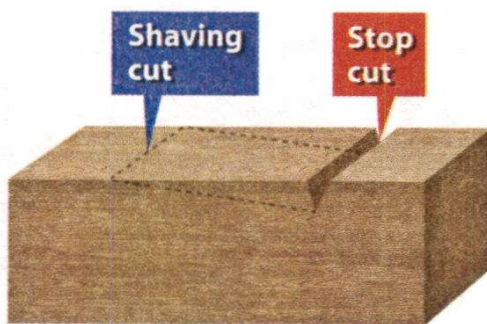

### MAKING STOP-CUTS

Here is a secret to use when you're whittling. Before you make a shaving cut, make a stop cut. At the place you want the shaving to stop, cut straight down with your knife. Press down and rock the blade back and forth until the cut is as deep as you want the shaving to go. This stop-cut will prevent you from shaving off too much wood.





## FIRST AID FOR KNIFE CUTS

Accidents can happen even when you're being careful. It is important that you know what to do if you or one of your fellow Scouts gets cut while using a pocketknife.

Small cuts in the skin can allow bacteria to enter the body and cause infection. Check to see if they have any allergies to the first-aid items that you plan to use. Wash minor cuts with soap and water. Apply first-aid ointment and cover with a dry, sterile dressing or an adhesive bandage to help prevent infection and protect the wound. Clean and rebandage wounds each day. If the cut is more serious, get help from an adult immediately.

Taking proper care of a wound will help prevent other health issues like an infection.



\_\_\_\_\_

Date

\_\_\_\_\_

Adult's Signature

## REQUIREMENT 4

### Make two carvings with a pocketknife.

It is fun to whittle sticks, but it's even more fun to make carvings of things like animals, acorns, and space aliens. A good way to learn to carve is to practice with a bar of soap. Carve a simple item and then try something a little harder.

#### What You Will Need

- ▶ A large bar of soap — it's best to unwrap the soap and let it dry for a day or two before you start carving
- ▶ A pocketknife
- ▶ One or two orangewood sticks (used for manicures) or a sheet of tracing paper
- ▶ Paper for sketching a design or a preprinted pattern
- ▶ A tray to work on — this will keep chips and shavings from going everywhere

#### WHAT TO DO

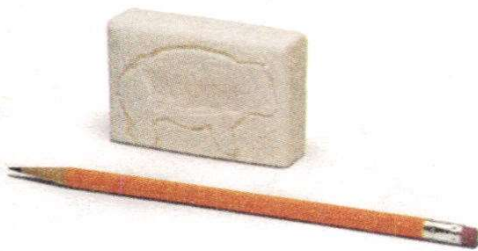

1. Choose a simple design that does not have too many projections or fine details. Start simple. You can pick a fancier design for your next carving.

2. Prepare the soap. Cut away the raised edges on the soap and scrape off the lettering. This will give you a nice, smooth block to work with.





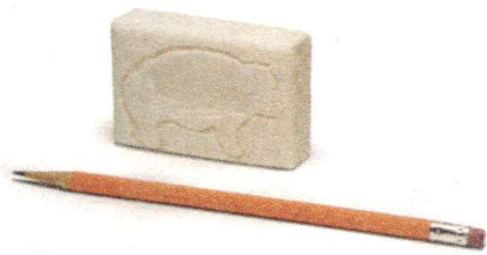

3. Sketch the outline of your design on the soap. You can do this by drawing with an orangewood stick or by tracing your design using tracing paper.

4. Make your first rough cuts. Cut away small pieces and slices of the soap that are not part of your design. Do not cut big pieces; if you do, the soap might break. Leave a margin of about one-quarter inch outside your outline.



5. Shape the model. Continue carving so you get closer and closer to your outline. Keep turning the soap to work on all parts of your design. Do not try to finish one part before another. Pay special attention to high points and low points on the carving.

6. Polish your carving. Let the soap dry for a day or two, then rub it gently to smooth it out. Use a paper napkin first and then your fingertips.



7. Add detail. Finally, use your knife to add details like eyes or hair. If you like, create a crisscross pattern to give the carving more depth.



\_\_\_\_\_

Date

\_\_\_\_\_

Adult's Signature

## **Special Thank You**

On behalf of the BSA, a special thank you to the more than 25,000 volunteers and parents who provided feedback and guidance in developing the updates for the Cub Scout program that are reflected in this handbook.

A special thank you to Lisa Wylie, who served as the national Cub Scouting chair from 2019 to 2022 and continued as the project manager for the Cub Scouting program updates. She gave exceptional leadership to the committee, to subject matter experts, and to staff. These revisions would not have happened without her leadership.

A special thank you to Audrey Oakes, chair of the National Cub Scouting Committee; Mike Rooney, national Cub Scouting commissioner; and Anthony Berger, national director of Cub Scouting, who serve as the Key 3 for Cub Scouting.

A special thank you to members of the National Cub Scouting Committee who have worked together in various groups and projects to make these revisions a reality.

## **Members of the National Cub Scouting Committee**

Dan Ayers

Ben Orloff

Sara Banks

Linze Pattison

James Carroll

Barb Perez

Tamara Christensen

Sherry Smothermon-Short

Grace Puente Davidson

Patty Spear

Jenny Rhea Eisenhauer

Shelley Sprouffs

Janet Griffin

Mike Tharp

Lionel Jellins

Ryan Vise

Scott Larson

Erica Worthy

Eddie Lovett

Zach McCarty



## **Acknowledgments**

The updated Cub Scouting program was developed in partnership with national and local Cub Scout volunteers and parents, along with subject matter experts.

### **Required Adventures – Subject Matter Experts**

Sid Groutage	BSA volunteer, Pacific Harbors
Matthew Lundh	City council member, Cle Elum, Wash.
Michael Charles	Political campaign consultant
Brandon Hersey	Seattle School Board member
Kara Bowers	Registered dietician
Angela Schlegel	Registered dietician
Brian Christianson	Physical education teacher
Missy Kilbey	Physical education teacher
Warren Franke	Professor, Department of Kinesiology
Teayre Klosterman	Physical education teacher
Heather Oster	BSA volunteer
Jason Nolan	President, P.R.A.Y.
Kevin Litt	UCP Heartland
Shirin Hamraei	Special education teacher
Merri Bolen	Association of Baptist for Scouting
Dustin Shoemake	BSA executive, retired
Mark Strunk	Marriage and Family Therapist

### **Required Adventure – Curriculum Review**

C. Centée Richards, Ph.D.

Prescott College, associate dean of education

Diane Shanafelt, M.A. Ed.

Morningside College, assistant professor of education

Matthew Vick, Ph.D.

University of Wisconsin-Whitewater

Dean of graduate studies and continuing education

Chris Wyveen, Ph.D.

Baylor University, associate professor of recreation

Sylvia Price, Ed.D.

### **Elective Adventures – Subject Matter Experts**

Mark Watson

Pat Fountain

Jamie Green

Debbie Warren

Craig Warren

Mike Volz

Debra Hinterbrand

Jacque Alvernaz

Paula Church

Elizabeth Morgan

Elizabeth Mithran

Mark Griffin

Jeremy Piwowarczyk

John Duncan

Beth Katz

Jason Kralj

Ryan Larson

Janet Rohmiller, M.A.Ed.

Jan Billeb, Executive Director – Knife Safety & Tool Institute

### **Scouts BSA Content for Arrow of Light**

Angelique Minett – Scouts BSA chair

Jeff Bostwick – Scouts BSA chair (2019-2023)

Laurie Champion

Dale Rae

CC Hardin



## **BSA Volunteer Committees**

Program Development Committee: Pat Noack – chair, Jennifer Hancock – chair 2019-2022, and members of the Program Development Committee.

Outdoor Programs Committee: Dan Segersin – chair, and Andrea Watson – national director of Outdoor Programs, and the members of the Outdoor Programs Committee.

Camping and Trekking Committee: Russ and Rose Hunsaker – co-chairs and members of the committee.

Range and Target Sports Committee: Mark Abramson – chair and members of the committee.

Aquatics Committee: Terrence Budd – chair and members of the committee.

Conservation: Mike Huneke – chair and members of the committee.

Outdoor Ethics: Scott Anderson – chair and members of the committee.

Wheels and Board Sports: Warren Wenner – chair and members of the committee.

Fishing: Ben Jelsema – past chair and members of the committee.

Disability Awareness Committee: Brent Worley – chair and members of the committee.

Safe Scouting Committee: David Berry – chair, Richard Bourlon – national director of Health and Safety, Bev Singel, R.N. – Health Consultant, Dr. Tim Brox, and members of the committee.

## **Image Credits**

### **Page 003:**

Photographs: Dan Bryant;  
Michael Roytek

### **Page 008:**

Photograph: BSA File Photo

### **Page 010:**

Photograph: Getty Images/  
Istockphoto

### **Page 012:**

Photograph: Getty Images/  
Istockphoto

### **Page 014:**

Photograph: Michael Roytek

### **Page 015:**

Photographs: Michael Roytek  
(2)

**Page 016:** Photographs: Michael  
Roytek; Dan Bryant

**Page 018:** Photographs: Dan  
Bryant

**Page 023:** Photograph: BSA File  
Photo

**Page 024-028:** Photographs: BSA  
File Photo (6)

**Page 030:** Photograph: Getty  
Images/Istockphoto

**Page 032:** Photograph: Tom  
Copeland

## **Bobcat**

### **Page 034:**

Photograph: Michael Roytek

### **Page 037:**

Photograph: W. Garth Dowling

### **Page 038:**

Photograph: Michael Roytek

### **Page 041:**

Photograph: Dan Bryant

### **Page 042:**

Photograph: Randy Piland

### **Page 044:**

Photograph: Michael Roytek  
(2); Dan Bryant

### **Page 045:**

Photograph: Michael Roytek

### **Page 046:**

Photograph: Al Drago

## **Bear Habitat**

### **Page 048:**

Photograph: Michael Roytek

### **Page 050:**

Photograph: Michael Roytek (6)

### **Page 051:**

Photograph: Dan Bryant

### **Page 052:**

Photograph: Getty Images/  
Istockphoto

### **Page 054:**

Photograph: Michael Roytek

### **Page 055:**

Photograph: Dan Bryant

### **Page 058-60:**

Photograph: Getty Images/  
Istockphoto (5)

### **Page 062:**

Photograph: Michael Roytek



## **Bear Strong**

### **Page 064:**

Photograph: Randy Piland

### **Page 066-067:**

Photographs: Getty Images/  
Istockphoto (5)

### **Page 068:**

Photographs: Randy Piland (2)

### **Page 069:**

Photographs: Dan Bryant (6)

### **Page 070- 071:**

Photographs: Getty images/  
Istockphoto (2)

## **Bear Paws for Action**

### **Page 074:**

Photograph: BSA File Photo

### **Page 076:**

Illustrations: Mr.Taz; Hashie

### **Page 077:**

Illustrations: Devin Cook; Carl  
Lindberg; Jacobulos; Anomie

### **Page 078-79:**

Illustrations: Rob Schuster (8)

### **Page 080:**

Photographs: Shutterstock (2)

### **Page 082:**

Photographs: Shutterstock (2)

### **Page 083:**

Photographs: Getty Images/  
Istockphoto (3)

### **Page 084:**

Photograph: Getty Images/  
Istockphoto

## **Standing Tall**

### **Page 088:**

Photograph: Dan Bryant

### **Page 090-91:**

Illustrations: Barbara Sinatra  
Children's Center Foundation  
(3)

### **Page 092-095:**

Getty Images/Istockphoto (8)

## **Bear Fellowship**

### **Page 096:**

Photograph: Michael Roytek

### **Page 098:**

Photograph: Roger Morgan

### **Page 099:**

Photograph: Michael Roytek

### **Page 100:**

Photograph: Randy Piland

## **Bear Goes Fishing**

### **Page 102:**

Photograph: Dan Bryant

### **Page 106:**

Photographs: Getty Images/  
Istockphoto (2)

### **Page 109:**

Photographs: Shutterstock;  
Getty Images/Istockphoto

### **Page 110:**

Photographs: Shutterstock;  
Getty Images/Istockphoto

### **Page 111:**

Photographs: Shutterstock;  
Getty Images/Istockphoto (3)

### **Page 112:**

Photograph: Getty Images/  
Istockphoto

**Page 114-115:**

Illustrations: Rob Schuster (2)

**Page 116:**

Photograph: Randy Piland (4)

**Page 117:**

Photograph: Jesse Scofield/  
BSA File Photo

## **Balancing Bears**

**Page 118:**

Photograph: Dan Bryant

**Page 120-125:**

Photographs: Getty Images/  
Istockphoto (19)

## **Baloo The Builder**

**Page 126:**

Photograph: Tom Copeland/  
BSA File Photo

**Page 128:**

Illustration: Rob Schuster

**Page 129:**

Photograph: Tom Copeland;  
Illustration: Rob Schuster

**Page 130:**

Photograph: Tom Copeland;  
Illustration: Rob Schuster

**Page 131:**

Illustration: Rob Schuster

**Page 131:**

Photograph: Tom Copeland;  
Illustration: Rob Schuster

**Page 132:**

Photograph: Tom Copeland;  
Illustration: Rob Schuster

**Page 133:**

Illustrations: Rob Schuster (3)

**Page 134:**

Photograph: Tom Copeland;  
Illustration: Rob Schuster

**Page 135:**

Photograph: Shutterstock;  
Illustration: Rob Schuster

**Page 137:**

Photograph: Shutterstock

**Page 140:**

Photograph: Roger Morgan

**Page 141:**

Photograph: Roger Morgan;  
Courtesy of Will Peterson

**Page 142:**

Illustrations: Rob Schuster (4)

**Page 143-149:**

Illustrations: David J. Brooks  
(19)

**Page 150-151:**

Photographs: Shutterstock (4)

## **Bears Afloat**

**Page 152:**

Photograph: BSA File Photo

**Page 154:**

Photograph: Getty Images/  
Istockphoto

**Page 155:**

Photographs: BSA File Photo;  
Getty Images/Istockphoto

**Page 156:**

Photograph: Getty Images/  
Istockphoto

**Page 157:**

Photograph: Getty Images/  
Istockphoto (3)

**Page 158:**

Photograph: Michael Roytek

**Page 161:**

Photograph: Getty Images/  
Istockphoto

**Page 162:**

Illustration: Rob Schuster (2)



**Page 163:**

Illustration: Rob Schuster; John McDearmon

**Page 164:**

Illustration: John McDearmon (5).

**Page 165:**

Photograph: Jesse Scofield/  
BSA File Photo

**Bears on Bikes**

**Page 166:**

Photograph: BSA File Photo

**Page 168:**

Photograph/Illustration: no credit needed

**Page 169:**

Photograph: BSA File Photo

**Page 170-171:**

Photograph: Getty Images/  
Istockphoto (3)

**Page 172:**

Illustrations: Donald Wu (2)

**Page 173:**

Photograph: Shutterstock;  
Getty Images/Istockphoto

**Page 174:**

Photograph: Randy Piland

**Page 175:**

Illustrations: Shutterstock; BSA  
File

**Page 176:**

Photographs: Getty Images/  
Istockphoto (3)

**Page 177:**

Photographs: Michael Roytek;  
Getty Images/Istockphoto

**Page 178:**

Photograph: Getty Images/  
Istockphoto

**Page 179:**

Photograph: Randy Piland/BSA  
File photo

**Champions of Nature**

**Page 180:**

Photograph: Randy Piland

**Page 182:**

Photograph: Getty Images/  
Istockphoto (3)

**Page 183:**

Illustration: Getty Images/  
Istockphoto

**Page 184:**

Photograph: Shutterstock (6)

**Page 185:**

Photograph: BSA File Photo

**Page 186-187:**

Photograph: Michael Roytek (6)

**Page 188:**

Photograph: Randy Piland

**Page 189:**

Illustration: Getty Images/  
Istockphoto

**Chef Tech**

**Page 190:**

Photograph: Michael Roytek

**Page 192:**

Photograph: Getty Images/  
Istockphoto

**Page 193:**

Photograph: Michael Roytek

**Page 194-196:**

Photographs: Getty Images/  
Istockphoto (3)

**Page 197:**

Illustration: Marcie Rodriguez

## **Critter Care**

### **Page 198:**

Photograph: Randy Piland

### **Page 200:**

Photograph: Randy Piland

### **Page 201:**

Photograph: Shutterstock

### **Page 202:**

Photograph: Olivia Ogren-Hrejsa; Getty Images/Istockphoto

### **Page 203:**

Photograph: Shutterstock; Getty Images/Istockphoto (2)

### **Page 204:**

Photograph: Shutterstock; Getty Images/Istockphoto (2)

### **Page 205:**

Photograph: Getty Images/Istockphoto (2)

## **Forensics**

### **Page 206:**

Photograph: Brian Payne

### **Page 208:**

Photograph: Getty Images/Istockphoto

### **Page 209:**

Photograph: Dan Bryant

### **Page 210:**

Photograph: Fingerprints- BSA File Photo (3)

### **Page 211:**

Photograph: Randy Piland

### **Page 212:**

Photograph: Getty Images/Istockphoto

### **Page 213:**

Photograph: Dan Bryant

### **Page 216:**

Photograph: Michael Roytek (3)

### **Page 217:**

Photograph: Shutterstock

### **Page 218:**

Photograph: Shutterstock (3)

### **Page 219:**

Photograph: Phil Davis/BSA File Photo

## **Lets Camp**

### **Page 220:**

Photograph: Olivia Ogren-Hrejsa

### **Page 222:**

Photograph: Michael Roytek

### **Page 223:**

Photograph: Michael Roytek (6)

### **Page 226:**

Photograph: Michael Roytek

### **Page 227:**

Photograph: Michael Roytek

### **Page 228:**

Photograph: Getty Images/Istockphoto

### **Page 229:**

Photograph: Getty Images/Istockphoto

## **Marble Madness**

### **Page 230:**

Photograph: Michael Roytek

### **Page 231:**

Photograph: Getty Images/Istockphoto

### **Page 231:**

Photograph: Shutterstock

### **Page 232-233:**

Photograph: Michael Roytek (5)



**Page 234:**

Photograph: Shutterstock

**Page 236-239:**

Photograph: Michael Roytek (5)

**Race Time**

**Page 240:**

Photograph: Michael Roytek

**Page 242-245:**

Photograph: Michael Roytek (9)

**Page 248:**

Photograph: Roger Morgan

**Page 249-250:**

Photograph: Michael Roytek (2)

**Page 251:**

Photograph: Jesse Scofield

**Roaring Laughter**

**Page 252:**

Photograph: Olivia Ogren-Hrejsa

**Page 254:**

Photograph: Michael Roytek

**Page 256:**

Illustration: Aleksey Ivanov

**Page 257:**

Photograph: Michael Roytek

**Page 259:**

Photograph: Michael Roytek (2)

**Page 260-261:**

Illustrations: Aleksey Ivanov (6)

**Page 263:**

Photograph: Getty Images/  
Istockphoto (4)

**Salmon Run**

**Page 264:**

Photograph: Michael Roytek

**Page 266:**

Photograph: Michael Roytek

**Page 270-271:**

Photograph: Michael Roytek (3)

**Page 272:**

Photograph: Shutterstock

**Page 274-276:**

Photograph: Michael Roytek (3)

**Summertime Fun**

**Page 278:**

Photograph: Phil Davis/BSA File  
Photo

**Page 280:**

Photograph: Michael Roytek;  
Charlie Simokaitis

**Page 281:**

Photograph: Phil Davis/BSA File  
Photo; Michael Roytek

**Super Science**

**Page 282:**

Photograph: Dan Bryant

**Page 284:**

Photograph: Getty Images/  
Istockphoto

**Page 286:**

Photograph: Dan Bryant

**Page 287-291:**

Photograph: Michael Roytek (9)

**Whittling**

**Page 292:**

Photograph: Oliva Ogren-Hrejsa

**Page 294-295:**

Photograph: Michael Roytek (4)

**Page 297:**

Photograph: Michael Roytek (3)

**Page 298:**

Photograph: Michael Roytek;

Illustration: Rob Schuster

**Page 299:**

Photograph: Brian Payne

**Page 300-301:**

Photograph: Roger Morgan (7)

All other images not mentioned above are the property of or are protected by the Boy Scouts of America.



# OFFICIAL PLACEMENT OF INSIGNIA



**BOBCAT**  
(CHARACTER & LEADERSHIP)

**BEAR HABITAT**  
(OUTDOORS)

**BEAR STRONG**  
(PERSONAL FITNESS)

**PAWS FOR ACTION**  
(CITIZENSHIP)

**STANDING TALL**  
(PERSONAL SAFETY AWARENESS)

**FELLOWSHIP**  
(FAMILY & REVERENCE)

A BEAR GOES FISHING

BALANCING BEARS

BALOO THE BUILDER

BEARS AFLOAT

BEARS ON BIKES

CHAMPIONS FOR NATURE

CHEF TECH

CRITTER CARE

FORENSICS

LET'S CAMP

MARBLE MADNESS

RACE TIME

ROARING LAUGHTER

SALMON RUN

SUMMERTIME FUN

SUPER SCIENCE

WHITTLING

# SCOUT OATH

On my honor I will do my best  
To do my duty to God and my country  
and to obey the Scout Law;  
To help other people at all times;  
To keep myself physically strong,  
mentally awake, and morally straight.

# SCOUT LAW

Trustworthy

Loyal

Helpful

Friendly

Courteous

Kind

Obedient

Cheerful

Thrifty

Brave

Clean

Reverent



SKU 660352



34753

2024 Printing

BOY SCOUTS OF AMERICA  
1325 West Walnut Hill Lane / P.O. Box 152079  
Irving, TX 75015-2079 / [www.scouting.org](http://www.scouting.org)